

ALASKA LEGISLATURE COMMITTEE FILES 1991-1992 8672

6818 HOUSE HEALTH EDUCATION & SOCIAL SERVICES

STATE OF ALASKA
1991 LEGISLATIVE SESSION

BILL NO. HB 103

Revision Date: _____
Title: An Act Relating to the
Fingerprinting of Minors
Sponsor: Rep. Donlev
Requestor: House Judiciary

Department Affected: Public Safety
BRU: DPS Statewide Support
Component: AK Criminal Records & ID

COMPONENT SERIAL NO.

1	1	9	0
---	---	---	---

EXPENDITURES/REVENUES: (Thousands of Dollars) (Inflation not Included)

OPERATING	FY 92	FY 93	FY 94	FY 95	FY 96	FY 97
PERSONAL SERVICES	10.0	10.0	10.0	10.0	10.0	10.0
TRAVEL						
CONTRACTUAL						
SUPPLIES						
EQUIPMENT						
LAND & STRUCTURES						
GRANTS, CLAIMS						
MISCELLANEOUS						
TOTAL OPERATING	10.0	10.0	10.0	10.0	10.0	10.0

CAPITAL	0	0	0	0	0	0
---------	---	---	---	---	---	---

REVENUE	0	0	0	0	0	0
---------	---	---	---	---	---	---

FUNDING: (Thousands of Dollars)

GENERAL FUND	10.0	10.0	10.0	10.0	10.0	10.0
FEDERAL FUNDS						
OTHER/PROG RCPT						
TOTAL	10.0	10.0	10.0	10.0	10.0	10.0

POSITIONS:

FULL-TIME	0	0	0	0	0	0
PART-TIME	0	0	0	0	0	0
TEMPORARY	0	0	0	0	0	0

Estimate of current year impact _____

ANALYSIS: (Attach a separate page if necessary)

(See attached).

Prepared by: Ken Bischoff Phone: 465-4336
Division: Administrative Services Date: 1/25/91

Approved by Commissioner: *Richard L. Burton* Richard L. Burton
Agency: Department of Public Safety Date: 2/07/91

Distribution (by preparer): Legislative Finance, Legislative Sponsor, Requestor, OMB, & Impacted Agency(ies).

ANALYSIS:

This bill would allow the fingerprinting of juveniles age 14 or older who are arrested for criminal offenses. These fingerprints would be compared with latent (crime scene) prints contained in the Alaska Automated Fingerprint Identification System (AAFIS). The DPS Records and Identification Section operates the Alaska Automated Fingerprint Identification System (AAFIS) and maintains criminal history record information used by police and other criminal justice agencies.

This bill would have a positive impact on the ability of police to solve cases involving juvenile offenders. Over 40% of all persons arrested for burglary and theft are juveniles. Many other crimes remain unsolved, however, as fingerprint evidence frequently found at the scene is not matched to any suspect because juveniles are not fingerprinted. AAFIS records indicate that 22% of the crime scene prints identified by the system since 1985 have been from first-time adult arrests which matched latent prints taken from crimes committed when the offender was a juvenile. Of these cases 86% were for burglary and theft offenses. Had these persons been fingerprinted as juvenile offenders they could have been identified, solving additional cases, and enabling the court to consider the offender's complete conduct when deciding the disposition of a case.

Existing AAFIS staff are not able to keep current with their present work load. Additional funding is required in Personal Services to increase the staff months of a part-time position approved for this unit for FY91 under a fiscal note for HB 52 (Chp 7 SLA 1990). The increased work load expected as a result of this bill is estimated as follows:

Estimated number of juvenile fingerprint cards	-	2700
Total time to complete 15 processing steps	-	504 hrs
Clk IV - Range 9A (4.0 months)		

*
* DELIVER TO: LHSCHES *
*
* ORIGINAL *
* SENT: 02/20/91 TIME: 09:34 *
* FROM: LIOCLAI *
* SUBJECT: 91-02-089;FS;DOMEST VIOL;2-20 *
* PRINT DATE: 02/20/91 TIME: 09:34 *
*

SUBJECT LINE TO READ: TC NO.;SHORT SUBJECT;DATE

T/C NO: 91-02-089
DATE: 02-20-91
SPONSOR: (H) HEALTH, EDUCATION & SOCIAL SERVICES
SUBJECT: HB 44, HB 103
MODERATOR: LANI
SITE: ANCHORAGE

FINAL STATS

WE HAD NO PARTICIPANTS AND DID NOT DIAL INTO THE TELECONFERENCE

HOUSE COMMITTEE REPORT

(7)

Date Referred: February 4, 1991

FURTHER REFERRALS:

Judiciary
Finance

Date of Committee Action: 2/20/91

The HEALTH, EDUCATION AND SOCIAL SERVICES Committee considered:

HB 103

HOUSE BILL NO. 103

FINGERPRINTING OF MINORS

"An Act relating to fingerprinting of minors."

RECOMMENDATIONS:

- be replaced with _____ the same title
 a new title
- have attached amendments(s)
- do pass
- do not pass
- no recommendations
- individual recommendations
- additional referral to the _____ Committee

ADOPTS: _____ letter of Intent

ATTACHES NEW FISCAL NOTE(S):

(Dept)

APPROVES PREVIOUS:

(Dept/Date)

fiscal impact DPS \$10,000 1/25/91

fiscal note(s) _____

zero fiscal note _____

zero fiscal note(s) _____

SIGNING DO PASS:

SIGNING OTHER RECOMMENDATIONS:

	Check appropriate column:	Do Not Pass	No Rec	Amend
<i>Cheri Davis</i>				
<i>Mary Miller</i>				
<i>Mark Stanley</i>				
<i>Betty Davis</i>				
<i>John C. Douglas</i>	<i>John C. Douglas</i>		X	
<i>John C. Douglas</i>			X	

[Signature]
Chairman's Signature

Alaska State Legislature



House of Representatives House Judiciary Committee

P. O. Box V
State Capitol
Juneau, Alaska 99811
(907) 465-4990
(907) 465-4712

SPONSOR STATEMENT

House Bill 103 allows law enforcement authorities to place the fingerprints of minors who are arrested for committing a crime in the state fingerprint computer. The legislation will help prevent criminal behavior by giving police officers the tools necessary to solve crimes and by allowing the early apprehension of repeat juvenile offenders.

One of the single most important investigative tools available to law enforcement officers is the ability to match unidentified fingerprints taken from a crime scene with known fingerprints that are stored in the state fingerprint computer. This tool increases the ability of police to protect the public, and helps ensure that people who have committed criminal acts are identified, apprehended, and convicted. However, because the fingerprints of minors are rarely allowed to be placed in the state fingerprint computer, this tool is not available to solve crimes committed by juveniles. Since the majority of burglary arrests in Alaska are of juveniles between the ages of 14 and 18, the restriction on placing minors' fingerprints in the computer significantly hinders the ability of police to solve crimes.

From 1984 through 1989, the fingerprints of 124 persons arrested for the first time as adults were matched with unidentified latent fingerprints taken from the scenes of unsolved crimes that were committed when the arrestee was a juvenile. It is likely that these offenders could have been identified and arrested earlier, and before they committed criminal acts as adults, if authority existed to place the fingerprints of minors in the state fingerprint computer.

The legislation has been a priority of the Alaska Peace Officers' Association for many years, and is strongly supported by the Alaska Association of Chiefs of Police, the Department of Public Safety, and the Department of Law.

SPONSOR STATEMENT

BILL NO: HB 103

DATE: February 7, 1991

TITLE: An Act Relating to the
Fingerprinting of Minors

CONTACT: Gayle A. Horetski
Deputy Commissioner

POSITION PAPER / DEPARTMENT OF PUBLIC SAFETY

This bill would allow the fingerprinting of juveniles age 14 and older who are arrested for criminal offenses. The fingerprints would be taken for comparison with latent (crime scene) prints contained in the Alaska Automated Fingerprint Identification System (AAFIS).

This bill should have a positive impact on the ability of police to solve cases involving juvenile offenders. Over 40% of all persons arrested for theft and burglary offenses are juveniles (see attached chart). Fingerprint evidence is frequently found at crime scenes, but is not matched to any suspect because juveniles are not fingerprinted. A large number of theft and burglary offenses are "cleared" when adults are arrested and their fingerprints matched to latents from crimes committed when the offender was a juvenile. AAFIS records indicate that 22% of the crime scene prints identified by the system since 1985 have been from first-time adult arrests which matched latent prints taken from the scenes of crimes committed when the offender was a juvenile. See attached graph. Had these persons been fingerprinted as juvenile offenders they could have been identified, solving additional cases, and enabling the court to consider the offender's complete conduct when deciding the disposition of a case.

The Department of Public Safety supports HB 103.

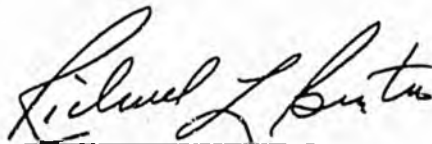

Richard L. Burton
Commissioner

Pub. Safety - Position Paper

JUVENILE ARRESTS*

	1987	%	1988	%	1989	%
MAJOR FELONIES**						
Total Arrests	990		1100		2090	
Juveniles	96	9.7%	97	8%		
BURGLARY						
Total Arrests	1041		960		1004	
Juveniles	475	46.0%	509	49%	527	52.5%
LARCENY						
Total Arrests	4934		4398		4487	
Juveniles	1754	36.0%	1624	37%	1761	39.2%
MOTOR VEHICLE THEFT						
Total Arrests	331		481		512	
Juveniles	166	50.0%	214	44%	272	53.0%

*Data obtained from the 24 agencies submitting UCR figures to DPS.

**Major Felonies = Combined figures for Murder, Manslaughter, Rape, Robbery and Aggravated Assault.



Alaska State Legislature
House of Representatives
 COMMITTEE ON HEALTH, EDUCATION
 AND SOCIAL SERVICES

DATE: February 20, 1991

PLACE: Capitol Room 106

SUBJECT OF MEETING:

HB 44 Amending Domestic Violence Laws
 *HB103 Fingerprinting of Minors

NAME	REPRESENTING	BUSINESS/PERSONAL MAILING ADDRESS	ZIP	(H) PHONE	(W) PHONE	DO YOU WANT TO TESTIFY?		WHAT SUBJECT/ WHICH BILL?
						Y	N	
(DO YOU WISH TO TESTIFY?)		(FILL OUT COMPLETELY!)				Y	N	
Barbara Miklos	Counsel on DV/SA	Pouch N Juneau 99811		345 345 435	465-4356	Y	<input checked="" type="radio"/> N	only of questions
						Y	N	
Margie Knuth	Assistant Attorney General D.O.L.	PO Box KC Juneau	99811		3428	<input checked="" type="radio"/> Y	N	HB 103
Gayle Horetzki	Deputy Commissioner DPS	PO Box N - Juneau Dep Com Pub Safety	99811		465-4322	<input checked="" type="radio"/> Y	N	HB 103
Laurie Otto	Council to HSEVD Committee	PO Box V - Juneau - AK RM 120, Cap. Bldg	99811		74990	Y	N	HB 103
						Y	N	
						Y	N	
						Y	N	
						Y	N	
						Y	N	

HB

127

3111 C STREET, SUITE 455
ANCHORAGE, ALASKA 99503
(907) 561-7628

WHILE IN SESSION
P.O. BOX V
JUNEAU, ALASKA 99811
(907) 465-3704

ALASKA STATE HOUSE



CHAIR
RULES COMMITTEE

JUDICIARY

SPECIAL COMMITTEE ON INTERNATIONAL
TRADE & TOURISM

LEGISLATIVE COUNCIL

REPRESENTATIVE JOHNNY ELLIS

MEMORANDUM

TO: Representatives Pat Carney and Georgianna Lincoln, Co-Chairs,
House Health, Education and Social Services Committee

FROM: Representative Johnny Ellis, Chair *JE*
House Rules Committee

RE: House Bill 127

DATE: February 25, 1991

Thank you for scheduling House Bill 127 for a hearing. There is one small amendment to be made to Section 1, page 2, lines 17-18. Nick Begich was not the [father of the state operated school system], he was the father of Alaska Kindergarten. Can we make that change in committee?

House Bill 127 adds a sixth scholarship to the memorial scholarship revolving loan fund currently in operation through the Commission on Postsecondary Education. The scholarship is in memory of former Alaska educator and Congressman Nick Begich.

The scholarship fund was created to assist students who plan to contribute knowledge to the state and promote a great future for the people of Alaska. Students who plan to major in public administration, government or education are eligible for an annual \$2,500 Nick Begich scholarship, to perpetuate the memory of Nick Begich, a great Alaskan who offered his expertise in both education and government.

Nick Begich came to Anchorage as a counselor at West High School in 1956. He taught at Ursa Minor elementary at Fort Richardson from 1958 to 1964 — eventually becoming the school superintendent. In 1962 he was elected to the Alaska State Senate and served two four-year terms. For one term he served as Chair of the Health, Education and Welfare Committee and established many education laws to Alaska Statutes. In 1970 Nick ran for Congress against Frank Murkowski and won, serving Alaska from 1971 until his untimely death in 1972.

There are two methods for funding the scholarship:

1. Direct donations to the scholarship fund.
2. State employees can donate accumulated leave time — in the amount that they would have been paid — to the scholarship fund.



FISCAL NOTE

STATE OF ALASKA
1991 LEGISLATIVE SESSION

BILL NO. HB 127

Revision Date: _____ Department Affected: Education
 Title: HB 127 "An Act establishing the Nick Begich Memorial Scholarship" BRU: Postsecondary Education
 Component: Memorial Scholarship Loans
 Sponsor: Representative Ellis
 Requestor: House HESS COMPONENT SERIAL NO.

0	2	1	3
---	---	---	---

Expenditures/Revenues: (Thousands of Dollars)

OPERATING	FY 92	FY 93	FY 94	FY 95	FY 96	FY 97
PERSONAL SERVICES						
TRAVEL						
CONTRACTUAL						
SUPPLIES						
EQUIPMENT						
LAND & STRUCTURES						
GRANTS, CLAIMS						
MISCELLANEOUS						
TOTAL OPERATING	-0-	-0-	-0-	-0-	-0-	-0-

CAPITAL						
---------	--	--	--	--	--	--

REVENUE						
---------	--	--	--	--	--	--

FUNDING: (Thousands of Dollars)

GENERAL FUND	-0-	-0-	-0-	-0-	-0-	-0-
FEDERAL FUNDS						
OTHER						
TOTAL	-0-	-0-	-0-	-0-	-0-	-0-

POSITIONS:

FULL-TIME	-0-	-0-	-0-	-0-	-0-	-0-
PART-TIME						
TEMPORARY						

Estimate of current year impact: _____

ANALYSIS: (Attach a separate page if necessary.) No fiscal impact within the time of this note, since all funds are contributions, and repayments begin after schooling and should be negligible due to 100 percent forgiveness eligibility.

Prepared By: Jane Byers Maynard, Executive Director Phone: 465-2165
 Division: Alaska Commission on Postsecondary Education Date: February 22, 1991
 Approved by Commissioner: _____ Date: _____
 Agency: _____ Date: _____

Distribution (by preparer): Legislative Finance, Legislative Sponsor, Requestor, OMB, & Impacted Agency(ies).

1991 LEGISLATION
POSITION PAPER
DEPARTMENT OF ADMINISTRATION

Division Finance Bill Number HB 127

Bill Title "An Act establishing the Nick Begich Memorial Scholarship"

Position Statement: Explain briefly what bill does, its impacts and Department's position, i.e. a) support, b) do not support, c) neutral or d) oppose.

This act establishes a Nick Begich memorial scholarship reserve account in the memorial scholarship fund (fund #21611).

This bill would not have an impact on the Division of Finance or Department of Administration. A procedure is in place to account for leave donations to all scholarship accounts in the fund. The Department of Administration takes a neutral position on this bill.

APPROVED:

Director Don Wanie Division Finance
print name

Signature *Joe Thomas* Date 2/25/91

Commissioner Millett Keller

Signature *Millett Keller* Date 2/25/91

(For more information, call Barbara Pritchett 465-2200)

Rev. 1/23/91

FISCAL NOTE

STATE OF ALASKA
1991 LEGISLATIVE SESSION

BILL NO. HB 127

Revision Date: _____ Department Affected: Administration
 Title: "An Act establishing the Nick Begich memorial scholarship" BRU: Central Services
 Component: Finance
 Sponsor: Representative Ellis
 Requestor: _____ COMPONENT SERIAL NO.

59			
----	--	--	--

Expenditures/Revenues: (Thousands of Dollars)

OPERATING	FY 92	FY 93	FY 94	FY 95	FY 96	FY 97
PERSONAL SERVICES	0	0	0	0	0	0
TRAVEL	0	0	0	0	0	0
CONTRACTUAL	0	0	0	0	0	0
SUPPLIES	0	0	0	0	0	0
EQUIPMENT	0	0	0	0	0	0
LAND & STRUCTURES	0	0	0	0	0	0
GRANTS, CLAIMS	0	0	0	0	0	0
MISCELLANEOUS	0	0	0	0	0	0
TOTAL OPERATING	0	0	0	0	0	0

CAPITAL	0	0	0	0	0	0
---------	---	---	---	---	---	---

REVENUE	0	0	0	0	0	0
---------	---	---	---	---	---	---

FUNDING: (Thousands of Dollars)

GENERAL FUND	0	0	0	0	0	0
FEDERAL FUNDS	0	0	0	0	0	0
OTHER	0	0	0	0	0	0
TOTAL	0	0	0	0	0	0

POSITIONS:

FULL-TIME	0	0	0	0	0	0
PART-TIME	0	0	0	0	0	0
TEMPORARY	0	0	0	0	0	0

Estimate of current year impact: _____

ANALYSIS: (Attach a separate page if necessary.)

This Act will not have an impact on the Division of Finance or the Department of Administration. Procedures are in place to account for all leave donations to the other scholarship accounts in the memorial scholarship fund.

Prepared By: Weldon L. Blackwell *[Signature]* Phone: 465-2240

Division: Finance *[Signature]* Date: 02/25/91

Approved by Commissioner: Millet Kellea *[Signature]* McB *[Signature]* SMK *[Signature]*

Agency: Administration Date: 2/25/91

Distribution (by preparer): Legislative Finance, Legislative Sponsor, Requestor, OMB, & Impacted Agency(ies).

HOUSE COMMITTEE REPORT

(7)

Date Referred: February 8, 1991

FURTHER REFERRALS:

Finance

Date of Committee Action: 02/26/91

The HEALTH, EDUCATION AND SOCIAL SERVICES Committee considered:

HB 127

HOUSE BILL NO. 127

NICK BEGICH SCHOLARSHIP

"An Act establishing the Nick Begich memorial scholarship."

RECOMMENDATIONS:

be replaced with _____ [] the same title

[x] have attached amendments(s) [] a new title

[x] do pass

[] do not pass

[] no recommendations

[x] individual recommendations

[] additional referral to the _____ Committee

ADOPTS: _____ letter of Intent

ATTACHES NEW FISCAL NOTE(S): (Dept) _____

APPROVES PREVIOUS: (L. rpt/Date) _____

[] fiscal impact _____

[] fiscal note(s) _____

[] zero fiscal note _____

[] zero fiscal note(s) _____

SIGNING DO PASS:

SIGNING OTHER RECOMMENDATIONS:

	Check appropriate column:	Do Not Pass	No Rec	Amend
<i>Cheri L. Davis</i>				
<i>Robert Carey</i>				
<i>John L. Gault</i>				
<i>Mark Stanley</i>				

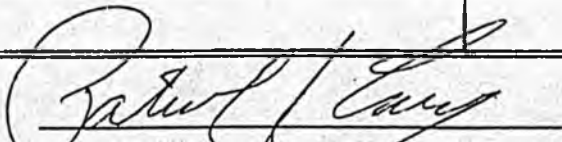

 Chairman's Signature

AMENDMENT

OFFERED IN THE HOUSE

BY REPRESENTATIVE ELLIS

TO: HB 127

Page 2, lines 17 - 18:

Delete "the Alaska state operated school system"

Insert "Alaska kindergarten"

H B

1 3 2

March 4, 1991

Representative Richard Foster
P.O. Box V
Juneau, Alaska 99811

Dear Rep. Foster:

I am writing in support of H.B. 132, which would make a special appropriation for elevators on the state ferries LeConte and Aurora.

I have personally been working toward this goal for several years, contacting my former legislator and state officials. I am the mother of a nine-year-old boy, Logan, who experiences disabilities, specifically cerebral palsy. We live in Klawock, and have had to do extensive travelling over the years to obtain medical care and therapy services.

The lack of handicapped access on these two ferries has been a real hardship on this family, and continues to be presently. So many times, we had to wait until all other passengers had departed. Then, ask crew members or strangers to assist with carrying him up and down the steps in his stroller, which is a real safety hazard.

Now that he is age nine and weighs over 90 pounds, that is no longer an option. He struggles to get up the steps. He has depth perception difficulties, and is very afraid while trying to walk down the three flights of steps. It requires two adults to assist, for safety's sake, which causes financial hardship - his Dad must leave the business for the duration and pay the additional travel expenses, or we have to hire assistance and pay for it.

I commend this attempt to at last recognize this serious, degrading situation and remedy it. Please let me know if there is any way I can be of assistance.

Thank you for your support.

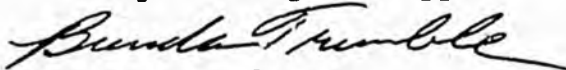

Brenda Trumble
P.O. Box 136
Klawock, Alaska 99925 (907) 755-2278

cc: Rep. Jerry Mackie

MISC. correspondence



Grand Camp
Alaska Native Brotherhood

RESOLUTION NO. 08

TITLE: ELEVATORS FOR FERRIES SERVING THE CANOE
COMMUNITIES

Whereas, The State of Alaska did not hear our voice in
convention in Klawock or again in Moonah for the
need of elevators for our Elders on the ferry
system, and

Whereas, our voice needs to be heard now for the needs that
we express, and

Whereas, we need for them to picture their mothers, their
fathers, their grandmothers and grandfathers
climbing and climbing those seemingly endless
stairs up to the top deck of the Alaska ferry, for
them to experience the frustrations that we have
on behalf of our Elders.

NOW THEREFORE BE IT RESOLVED, that the Alaska Native
Brotherhood and the Alaska Native Sisterhood
meeting in convention in Kake, Alaska during the
week of October 14 - 20, 1990 we, once again,
urge and remind the State of Alaska of the State
law for accessibility for the handicapped to the
public areas, and which includes our Elderly in
this law, and, for the message to our State
legislature to be heard in "GETTING ELEVATORS IN
OUR FERRY SYSTEM FOR THE CANOE COMMUNITIES" as
soon as possible, and

BE IT FURTHER RESOLVED, that copies of this resolution be
sent to the State Dept. of Transportation Marine
Highway System, the State legislature and the
Governor of Alaska.

ATTEST: I certify that this
resolution was adopted by the
ANB/ANS Grand Camp in convention
in Kake, Alaska during the week of
Oct. 14 - 20, 1990.

Albert Kookesh

Albert Kookesh
Grand President

Andrew Ebona

Andrew Ebona
Grand Secretary

ANB Resolution

HOUSE COMMITTEE REPORT

(7)

Date Referred: February 11, 1991

FURTHER REFERRALS: Health, Education and Social Services
Finance

Date of Committee Action: 4/23

The TRANSPORTATION Committee considered:

HB 132

HOUSE BILL NO. 132

APPROP: HANDICAPPED ACCESS ON FERRIES

"An Act making a special appropriation to the Department of Transportation and Public Facilities, Alaska marine highway system, for handicapped access on certain state ferries; and providing for an effective date."

RECOMMENDATIONS:

be replaced with CS HB 132 (transp) the same title a new title

have attached amendments(s)

do pass

do not pass

no recommendations

individual recommendations

additional referral to the _____ Committee

ADOPTS: Transportation Committee letter of Intent

ATTACHES NEW FISCAL NOTE(S): (Dept)

APPROVES PREVIOUS: (Dept/Date)

fiscal impact: _____

fiscal note(s) _____

zero fiscal note _____

zero fiscal note(s) _____

SIGNING DO PASS:

SIGNING OTHER RECOMMENDATIONS:

	Check appropriate column:	Do Not	No Rec	Amend
		Pass		
<u>Richard [Signature]</u>			*	
<u>Gail Sullivan</u>				
<u>[Signature]</u>				
<u>Bill Hudson</u>				

Richard [Signature]
Chairman's Signature

Alaska State Legislature

House of Representatives



Pouch V
State Capitol
Juneau, Alaska 99811
(907) 465-4858

Committee on Transportation

April 23rd, 1991

LETTER OF INTENT FOR HB 132

It is the intent of the House Transportation Committee to ensure that any device designed to provide handicapped accessibility on the M/V Aurora or M/V Leconte be usable by the elderly and handicapped in a safe and dignified manner.

Representative Richard Foster
Chairman, House Transportation Committee

TRA letter of Intent

REPRESENTATIVE
JERRY MACKIE

P. O. BOX 73
CRAIG, ALASKA 99821
(907) 826-3008 OFFICE
(907) 826-2930 HOME

CHAIRMAN,
COMMUNITY & REGIONAL AFFAIRS COMMITTEE

VICE CHAIRMAN,
TRANSPORTATION COMMITTEE

Alaska State Legislature



WHILE IN JUNEAU
P. O. BOX V
JUNEAU, ALASKA 99811
(907) 465-4925

House of Representatives

POSITION STATEMENT HB 132

HB 132, "An Act making a special appropriation to the Department of Transportation and Public Facilities, Alaska marine highway system, for handicapped access on certain state ferries, and providing for an effective", is legislation responding to concerns expressed by the elders and handicapped in the rural villages served by the small vessels of the system.

Access to these vessels is hampered by the lack of elevators available for use by wheel chair-bound users, persons unable to use the stairs due to loss of sight or limb, and the aged who have difficulty negotiating the narrow, steep stairs.

The rural village residents prefer to travel by ferry. This appropriation will reduce the stress of travel for those with infirmities who are the least able to leave the village and possibly have the greatest need to travel.

Sponsor Stmt.



*Department of Transportation
and Public Facilities*

**POSITION
PAPER**

BILL NO: HB 132

APPROVED:

W. F. Gerten

TITLE: An act making a special appropriation to DOT&PF, Alaska Marine Highway System, for handicapped access on certain state ferries; and providing for an effective date.

DATE: February 19, 1991

House Bill 132 appropriates \$800,000 to the Alaska Marine Highway System for the installation of elevators on the M/V LeConte and the M/V Aurora. This issue has been thoroughly analyzed in the last several years. All alternative locations for the installation of elevators on the vessels cause considerable disruption to the current operations and require modification to structural components. Several years ago, stair walkers were purchased for each vessel. These units require a crew member to assist a person confined to a wheel chair to negotiate the ships' stairways. We are reviewing an alternative device which operates on a track running parallel to the stair's handrail and apparently does not require the assistance of a crew member. At this time we do not support the installation of elevators on these vessels.

For Further Information contact Katy McHugh at 465-3900.

DOT POSITION PAPER

HOUSE COMMITTEE REPORT

(7)

Date Referred: April 24, 1991

FURTHER REFERRALS:

Finance

Date of Committee Action: 5-6-91

The HEALTH, EDUCATION AND SOCIAL SERVICES Committee considered:

HB 132

HOUSE BILL NO. 132

APPROP: HANDICAPPED ACCESS ON FERRIES

"An Act making a special appropriation to the Department of Transportation and Public Facilities, Alaska marine highway system, for handicapped access on certain state ferries; and providing for an effective date."

RECOMMENDATIONS:

be replaced with CS HB 132 (TRA) the same title a new title

have attached amendments(s)

do pass

do not pass

no recommendations

individual recommendations

additional referral to the _____ Committee

ADOPTS: _____ letter of Intent

ATTACHES NEW FISCAL NOTE(s): (Dept)

APPROVES PREVIOUS: (Dept/Date)

fiscal impact _____

fiscal note(s) _____

zero fiscal note _____

zero fiscal note(s) _____

SIGNING <u>DO</u> PASS	DP	OTHER RECOMMENDATIONS	DNP	NR	AM
		Mark Harley			
Mark Harley	✓				
Mary Miller	✓				
John C. Gonzales	✓	(GONZALES)			
Patricia Cook	✓	(CARNEY)			
Lincoln	✓	(LINCOLN)			

 CO CHAIRMAN'S SIGNATURE (LINCOLN)

Chapter 10. Public Works.

Article

- 1. Public Works Planning and Construction (§§ 35.10.010 — 35.10.080)
- 2. Boat Harbor, Dike, Jetty, and Breakwater Facilities (§§ 35.10.090 — 35.10.120)
- 3. Financial Provisions (§§ 35.10.130 — 35.10.135)
- 4. Public Facility Procurement Policy (§§ 35.10.160 — 35.10.200)
- 5. Utilities and Encroachments in Public Facilities (§§ 35.10.210 — 35.10.270)

Article 1. Public Works Planning and Construction.

Section

- 10. Standard plans and specifications and limitation on cost
- 15. Accessibility of public buildings and facilities
- 25. Compliance with local building codes
- 30. Inspecting and supervising public works construction
- 40. Failure of contractor to perform work

Section

- 50. Duty of department to examine and report on existing public buildings
- 60. Inspection and testing of materials
- 70. Research on public works
- 80. Statement of work authorized, completion schedule, and recommendations

Sec. 35.10.010. Standard plans and specifications and limitation on cost. The department shall prepare and adopt plans and specifications and determine standards for the construction of each public work. Each public work shall be limited in cost to the amount of the appropriation made for that purpose. The plans and specifications may be amended from time to time as the department considers advisable. This section does not apply to the construction of school buildings in incorporated cities, unless the construction is done in whole or in part with state funds, or to the construction of school buildings when the construction amounts to less than \$2,000. (§ Part III title III ch 152 SLA 1957)

Collateral references. — 64 Am. Jur. 2d, Public Works and Contracts, § 1 et seq.

Sec. 35.10.015. Accessibility of public buildings and facilities.

(a) The department shall prepare, adopt, and enforce regulations governing the construction of public buildings and facilities by or the state, including the University of Alaska, and its political divisions, whether financed in whole or in part by federal funds, to ensure that public buildings and facilities are accessible to, and usable by, the physically handicapped, aged, or infirm. The regulations of the department must conform to a standard comparable to applicable provisions of federal law, regulations, and standards.

(b) The department shall develop and maintain an inventory of all public buildings and facilities with respect to their compliance with the regulations adopted under (a) of this section. The department shall make an annual report to the governor and the legislature describing

work pe
building
the depa
ties for
conform
shall in
annual

(c) In
state a
departr
ferries
or othe
devices
physic
"access
aged o
decks
comfor
of the

(d)
comple
the di
the A
facilit
usable
stater
decks
and c
cappe
perao

(e)
may b
or otl
lisha
facili
the c
setti
facil
SLA
§§ 1

ES
amer
sente
gate

AS 35.10.010 - .080

work performed in the preceding calendar year to upgrade public buildings and facilities to conform with the regulations. In addition, the department shall develop cost estimates and recommended priorities for the upgrading of public buildings and facilities that do not conform with the regulations adopted under (a) of this section and shall include these estimates and the recommended priorities in the annual report to the governor and the legislature.

(c) In this section, "public facilities" includes vessels owned by the state and operated by the division of marine transportation of the department as a part of the Alaska marine highway system. All ferries owned or operated by the state shall be equipped with elevators or other passenger lifting equipment, ramps, or other facilities and devices to ensure that these vessels are accessible to and usable by physically handicapped, aged or infirm passengers. In this subsection, "accessible to and usable by" means that a physically handicapped, aged or infirm passenger can board, disembark and move between decks and about the public areas aboard a state ferry with personal comfort and safety, and with safety to, other passengers and members of the crew.

(d) After June 25, 1976, a ferry may not be constructed, lengthened, completely renovated, or purchased for use or entered into service by the division of marine transportation of the department as a part of the Alaska marine highway system that does not include adequate facilities and devices to ensure that the vessel is accessible to and usable by physically handicapped, aged or infirm passengers. Some staterooms and all restrooms, indoor passageways, outdoor weather decks, and other public areas aboard the vessel shall be so designed and constructed as to permit access and use by physically handicapped, aged or infirm passengers, including but not limited to those persons occupying a wheelchair.

(e) After June 25, 1976, no public building or facility in the state may be planned, designed, financed, constructed, opened to public use, or otherwise placed in operation unless it meets the standards established under this section. If the standards for a public building or facility are not provided for in federal law, regulation, or standards, the department shall determine the extent of, and adopt regulations setting the standards for, access to and use of the public building or facility by the physically handicapped, aged, or infirm. (§ 1 ch 119 SLA 1966; am § 1 ch 48 SLA 1972; am §§ 1 — 4 ch 249 SLA 1976; am §§ 1, 2 ch 23 SLA 1987)

Effect of amendments. — The 1987 amendment in subsection (a) in the first sentence substituted "adopt" for "promulgate" and made other minor word and

punctuation changes and rewrote the second sentence; and added the last sentence in subsection (e).

Sec. 35.10.020. Consultation with municipal planning commissions. [Repealed, § 4 ch 143 SLA 1977. For current law, see AS 35.30.]

Sec. 35.10.025. Compliance with local building codes. A public building shall be built in accordance with applicable local building codes including the obtaining of required permits. This section applies to all buildings of the state and corporate authorities of the state. (§ 1 ch 89 SLA 1968)

Cross references. — For other provisions relating to compliance with local ordinances and regulations, see AS 35.30.

Sec. 35.10.030. Inspecting and supervising public works construction. The department shall supervise and inspect the construction of public works and shall see that the work performed in constructing, repairing, altering or improving public works is in accordance with the drawings and specifications for them, that the interests of the state are fully protected, and that no person, firm, or corporation employed on any work performs the work in any other or different manner than is provided by the contract and the plans and specifications. (§ 3 art III title III ch 152 SLA 1957)

Sec. 35.10.040. Failure of contractor to perform work. If a contractor or person in charge of the construction of a public building in the state fails to perform the work in a good and workmanlike manner and does not perform the work in accordance with the plans and specifications of the contract, the department shall direct what legal action, if any, shall be taken. (§ 4 art III title III ch 152 SLA 1957)

Collateral references. — 64 Am. Jur. 72 C.J.S. Supplement, Public Contracts, 2d, Public Works and Contracts, § 81. § 40.

Sec. 35.10.050. Duty of department to examine and report on existing public buildings. The department shall, from time to time, examine all existing public buildings and report the condition of each and any necessary additional construction that is needed on them. (§ 4 art III title III ch 152 SLA 1957)

Cross references. — For provisions relating to thermal and lighting standards in public buildings, see AS 46.11.010.

Sec. 35.10.060. Inspection and testing of materials. The department may inspect and test materials, supplies, equipment and machinery used by a contractor constructing or maintaining public works, and may develop methods and procedures for inspection and testing. (§ 5 art III title III ch 152 SLA 1957)

Sec. 35.
gather, in-
struction
of efficien
and statis
ing mater
informati
(\$ 6 art :

Sec. 35
schedule
year, the
works au
schedule
the need
title III

- Art

Section;
90. Appl.
100. Dete
DD, prop

Sec. :
shall ap
federal
boat ha
ities ar
art IV

Sec.
depart
each p
and ap
by the
inform
the fin
which

Sec
ipatic
ticipa
inste
nity f
and f

§ 35.10.070

PUBLIC BUILDINGS, WORKS, ETC.

§ 35.10.110

Sec. 35.10.070. Research on public works. The department may gather, investigate and compile information concerning the use, construction and maintenance of public works, the practices and methods of efficient organization, financing and such other information, data and statistics of the state and the extent of natural resources of building materials in the state. The department shall disseminate this information, together with recommendations it considers advisable. (§ 6 art III title III ch 152 SLA 1957)

Sec. 35.10.080. Statement of work authorized, completion schedule, and recommendations. Not later than February 1 of each year, the department shall prepare a statement showing the public works authorized within the past six-year period and the completion schedule as of that date, together with recommendations regarding the need for additional public works construction, if any. (§ 7 art III title III ch 152 SLA 1957)

Article 2. Boat Harbor, Dike, Jetty, and Breakwater Facilities.

Section

90. Application for federal funds
100. Determining need and priority of projects

Section

110. Contracting with communities for local participation
120. Leasing marine or harbor facilities

Sec. 35.10.090. Application for federal funds. The department shall apply in the name of the state, as applicant, to the appropriate federal agency for the construction or assistance in the construction of boat harbor, dike, jetty or breakwater harbor facilities where the facilities are necessary, feasible and appropriate to the local economy. (§ 1 art IV title III ch 152 SLA 1957)

Sec. 35.10.100. Determining need and priority of projects. The department shall prepare the preliminary determination of need for each project of the type described in AS 35.10.090 and its feasibility and appropriateness through representations and data submitted to it by the residents of each community desiring a project, and from other information available to it. The department shall approve and make the final determination of those projects, and their order or priority for which application is made. (§ 2 art IV title III ch 152 SLA 1957)

Sec. 35.10.110. Contracting with communities for local participation. The department may contract with a community for the participation of the community either in the financing of projects or, instead of local financial participation, to contract with the community for its installing necessary piling, floats, and related equipment and facilities whether at the community's direct expense or through

THE FOLLOWING PAGES WERE TREATED AS
A UNIT IN THE ORIGINAL FILE.

THE FOLLOWING DOCUMENT MAY NOT FILM
LEGIBLY BECAUSE OF THE POOR QUALITY OF THE
ORIGINAL

MEMORANDUM

State of Alaska
Department of Transportation & Public Facilities

TO: Files

DATE: December 2, 1986

FILE NO: LCG&FM

TELEPHONE NO. 465-2734

FROM: Larry Woolford ^W
Project Manager
Marine Facilities Engineering
Alaska Marine Highway System

SUBJECT: Project #304033
F-9500(13), M/V
LeCONTE Galley
and Finishing Mod.

On November 28, 1986, AMHS headquarters personnel (*) met and reviewed the concept design and recommendations prepared by the Glostén Associates for the subject project. Pertinent comments attached.

AMHS personnel agreed and accepted the Glostén Associates recommended "enclosed hoistway" concept and elevator installation site #2 (approximate frames 33 to 36, starboard side forward of the machinery casing) as the optimum design.

AMHS personnel will perform vehicle maneuvering tests with a dummy hoistway obstruction in place to determine actual loading methods and capabilities with respect to 31', 40' and 45' vans.

The galley modifications are accepted as noted on the attached.

The central refrigeration system has been re-prioritized as "Alternate A" as this work lends itself to the modifications being addressed in the galley.

Subsequent discussion and agreement with Tom Shanley, Port Steward, eliminated the dining room seating revision as an alternate bid item. The same effect is accomplished under the bar relocation alternate.

dmd

Attachment

cc: Joe D. Camp, Deputy Commissioner, AMHS
A. H. McDonald, Port Engineer, Marine Operations, AMHS
J. McGrath, Sr. Const. Manager, Marine Facilities, AMHS
Kelly Mitchell, Port Captain, Marine Operations, AMHS
Harold Moeser, Director, Marine Facilities, AMHS
Tomas Shanley, Port Steward, Marine Operations, AMHS
Max Zbinden, Port Engineer, Marine Operations, AMHS

(*) Camp, Shanley, Mitchell, Diry & Woolford

071/larry2

MEMORANDUM

John
State of Alaska
Department of Transportation & Public Facilities

TO: Harold Moore
Director
Marine Facilities Engineering
Alaska Marine Highway System

FROM: Larry Woolford *LW*
Project Manager
Marine Facilities Engineering
Alaska Marine Highway System

DATE: January 30, 1987

FILE NO:

TELEPHONE NO: 465-2734

SUBJECT: M/V LeCONTE Galley & Finishings Modifications

During the period 1/9/87 through 1/23/87, a hoistway obstruction was placed on the main (car) deck in way of the proposed elevator site (#2 - Glosten Concept, dated 11/20/86).

It was anticipated that placement of this "dummy" hoistway would generate adequate information to determine the actual impact of the installation on the M/V LeCONTE's ability to transport vehicles greater than twenty-eight feet (28') in length, as referenced in the above report.

I have attached Captain D. Johnson's observations during this period. In addition, my own follow.

I visited the vessel on each arrival in Auke Bay (1/9, 1/11, 1/16, 1/18 and 1/23) specifically to witness loading operations. In each instance, several attempts were required to situate vehicles (31' to 40' excluding the tractor unit). It must be pointed out that the main deck in all cases was devoid of other vehicles, which afforded ample room to maneuver these units. However, this luxury normally would be precluded during peak traffic months by through traffic.

Discussions with the Chief Mate indicate that occasions arise that require using the turntable to load "booked" traffic in excess of twenty-eight feet (28'). The turntable will not function unless the applied weight is evenly distributed which causes a one to two foot (1' to 2') overhang of the vehicle being loaded with the turntable (turntable diameter is 32'). The elevator hoistway location is within eight inches (8") of the turntable perimeter. It appears that the turntable, depending on traffic, will be unusable.

The installed hoistway will eliminate the turning radius currently available and required to clear the transfer bridge when loading standard size vehicles in the "tunnel". The "tunnel" is presently loaded aft to forward by backing vehicles in. The hoistway location also reduces the effective "tunnel" width from eight to six feet (8' to 6') at the forward end. A standard vehicle is approximately six feet (6') in width excluding any

appurtenances (mirrors, etc.). The "tunnel" will be restricted to compacts and sub-compacts only unless through traffic is off-loaded to gain access to and from the after end for standard size vehicles. A portable ramp will be necessary to negotiate the height obstacle of the transfer bridge at the forward end of the "tunnel".

While it appears that the vessel can accommodate units larger than twenty-eight feet (28') in length, the actual capability cannot be documented under the conditions encountered. Furthermore, accessibility to and from the "tunnel" will be severely reduced.

I would suggest that this portion of the subject project be deferred until such time as the elevator installation can be accommodated in such a way as to not interfere with the vessel's present capabilities.

LW/mh

cc: Hugh McDonald - Port Engineer, Marine Operations, AMHS, Pier
48 Seattle
John McGrath - Sr. Const. Mgr., Marine Facilities, AMHS
Kelly Mitchell - Port Captain, Marine Operations, AMHS

SECTION II

ELEVATOR INSTALLATION

An elevator type and its installation site are to be determined for the LeCONTE. The elevator is to provide access for handicapped passengers between the main and passenger decks. It is generally accepted that there is no optimum site for the elevator and this installation will disrupt the vessel's current arrangement and/or loading/unloading operations. The goal then is to identify the viable options with their associated disruptions, and select a site, after formulating a plan to adapt operations to the re-configured vessel. This report section discusses the two general types of elevators, open and enclosed hoistway elevators; discusses elevator machinery; and ranks four sites for the recommended closed hoistway type elevator. The four sites are then further developed into conceptual plans, specifications, and cost estimates, and a recommendation is presented. Appendix A contains Alaska Marine Highway System's (AMHS) preliminary engineering work on open hoistway type installation sites and equipment, with a short commentary.

AMHS should make two decisions at this time. First the type of elevator is to be chosen: open or enclosed hoistway. Secondly the site is to be selected. The sites are dependent on the elevator type. Certain sites are appropriate to one type and not necessary applicable to the other, hence the type needs to be selected first. This decision process is illustrated below:

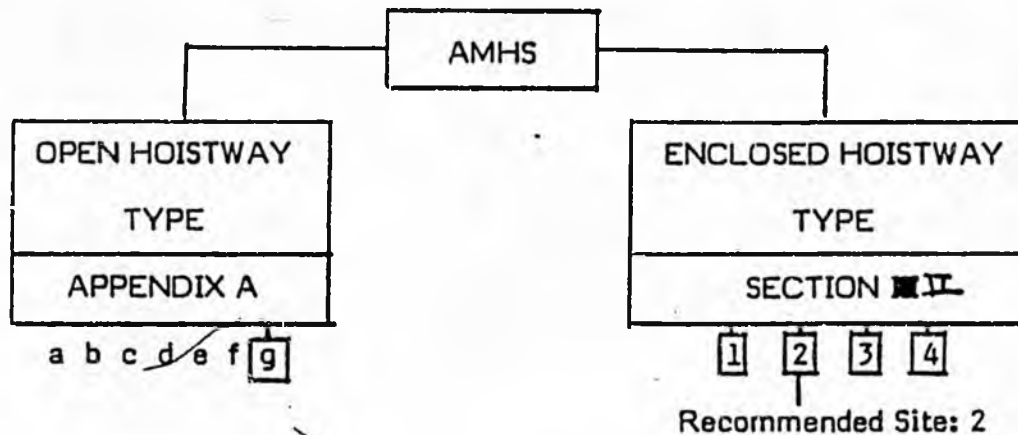

1. Open Versus Enclosed Hoistways

The hoistway is the vertical rectangular space that the elevator travels in. Open hoistway elevators as defined in this report do not enclose this space, enclosed hoistways of course do enclose the space, either with steel bulkheads or wire mesh. The open hoistway type elevator is appealing to this application because in the raised position, the main deck is free from obstruction. This type however cannot be recommended due to many important drawbacks discussed below.

The primary drawback to the open type elevator is safety. If the elevator stops midway and fire breaks out on the auto deck, people in the elevator have no fire protection. There is also the need for protection to the operating mechanisms, hoist equipment, and electrical travelling cables. Vertical gear racks attached to casing bulkheads, or an extended hydraulic cylinder, could be subject to damage from vehicular traffic. At least one crew is needed to operate the open hoistway type elevators. At the main deck he must insure that the landing area is free from obstruction, and he controls the operation from that station, using a key controlled interlock that must be held against a spring lockout to allow the elevator to be lowered. Release of this key would stop the elevator. Acceptance of the open hoistway type elevator by the U. S. Coast Guard is highly doubtful. Verbal discussions were held with the U. S. Coast Guard Marine Safety Center in Washington, D.C., and they were not favorable. A written request for confirmation has been sent, and at the time of this report, their response has not been received. This request is included in Appendix A. It discussed their primary concerns: fire and smoke passing between decks. Design features necessary to satisfy their concerns for public safety and fire control may negate any potential cost savings. Certification of elevators is not an ABS classification requirement, however we recommend that the elevator machinery and installation drawings be approved by ABS. ABS publishes a "Guide for Construction of Shipboard Elevators", and does not approve open hoistway type elevators.

The most significant problem with the open hoistway type is finding a vendor to assume the risk and supply this type of elevator. The appendix includes details of research conducted by Mr. George Dury, of AMHS, in which he first discovered this problem. In following up with his only positive responding vendor, Unidynamics/Midwest, they confirmed they would only supply an open hoistway elevator if waivers could be obtained from applicable agencies, in this case, the U. S. Coast Guard. Elevator vendors typically build elevators to the ANSI code (ANSI A17.1-1984; "American National Standard Safety Code for Elevators, Dumbwaiters, Escalators, and Moving Walks"), which although does not necessarily apply to shipboard elevators, does apply in public buildings. This code specifically requires elevator pits and enclosed hoistways.

Furthermore, ANSI A117.1-1980, the handicapped specifications, do not endorse an open hoistway type elevator. They specifically require the elevator to meet the ANSI elevator code.

In conclusion, open hoistway elevators are not appropriate for public use on board ship. While they have certain first cost savings over an enclosed hoistway elevator, they are not significant and the crew cost necessary to operate the elevator will soon negate the first cost advantage. We suggest that the disruption to the main deck be accepted and dealt with, and an enclosed hoistway shipboard elevator be installed.

2. Elevator Equipment

There are three types of enclosed hoistway elevators. The traction type utilizes a

traction winch at the top of the hoistway and a counterweight. While this type has been installed in ships, restraining the counterweight presents problems and adds to the expense of the system. High level speeds, up to 200 fpm, are attainable with this system.

The winding drum type utilizes a drum winch at the top of the hoistway, driven by an electric or hydraulic motor. The winding drum machines become quite complex and expensive with overtravel limits and brake requirements. ABS does not approve their use for transport of passengers, or for rated loads in excess of 1200 pounds. They also limit them to a maximum of 100 fpm and travel of 75 feet. This type should not be considered for passengers.

The hydraulic cylinder type elevator is the most economical and compact type, and the best selection for shipboard use. It does, however, have design limitations that may not be satisfied by the installation site requirements. Travel distance is generally limited to 20 feet, and speed is limited to about 100 fpm. Travel distances exceeding 20 feet can require a telescoping cylinder, which adds to expense. Also, because of the vertical orientation of the cylinder, the height of the hoistway from the bottom of the pit to the top of the enclosure needs to be slightly more than twice the travel distance. These limitations can be worked with on the LeCONTE. The hydraulic cylinder distance is about 17 feet, the 100 fpm speed would result in a 10 second ride from deck to deck, and in most of the proposed locations, the hoistway height requirement can be met. The hydraulic cylinder type is recommended for the LeCONTE, subject to confirmation of its application in preliminary design work.

Inquiries were made of two shipboard elevator vendors, as to price and their recommended type. Both recommended single plunger hydraulic type elevators. When asked about installation in a limited height hoistway, they noted additional costs would be involved. Copies of their proposals are provided in the Appendix.

3. Elevator Sites: Description and Ranking

Four sites for the enclosed hoistway elevator are presented. A ranking matrix, is developed where the various options are scored using a weighted evaluation method. AMHS should review the weighting and ratings, and develop their own scores for comparison.

The four sites presented were selected after a complete review of the vessel's arrangement and structural system. They are the only sites found that satisfy the basic objectives of the installation while minimizing interferences with the ship's operation. These basic objectives are the highest weighted in the ranking matrix:

- o Usability to handicapped passengers.
- o Minimal disruption to main deck operations and arrangement.
- o Minimal disruption to the vessel's arrangement and flow.

Three sites are forward, since 70% to 90% of the passengers board through the forward doors. A site through the crew's quarters on the starboard side amidships is not possible without eliminating some valuable crew space, blocking the starboard most car lane, or blocking the essential fore/aft passage accessing all the crew spaces. The aft starboard corner of the vessel was ruled out as it would eliminate the aft stairway which is essential as a second access to the crew's quarters, and it would block the steering gear access.

The four site selections are listed below, and further defined with plans, specifications, and cost estimates later in this section.

- o Site 1: Forward End Observation Lounge
- o Site 2: Forward End of Machinery Casing
- o Site 3: Port side location
- o Site 4: Aft port corner

4. Elevator Site 1: Forward End of Observation Lounge

This site has the following pros, cons, and basic elements:

- o Estimated cost: \$212,000
- o Major disruption: Arrangement. Forward lounge area would be severely re-arranged.
- o One front window in forward observation lounge is blocked.
- o About 6 seats in the forward lounge are lost.
- o The forward lounge is disrupted by dividing it into two halves with a recessed walkway.
- o One car space on main deck (forward between two stanchions) is lost.
- o The hoistway at main deck will interfere with the 2 foot overhang of trailers on the turntable.
- o While underway, wheelchairs can access forward observation lounge, but probably would not be desirable as they would be too low to see out of the windows.
- o Visibility from wheelhouse to fore deck is reduced.
- o Site is very accessible at main deck.
- o The site would have a detrimental effect on the outward appearance of the vessel.
- o Main deck structure will need modification as important longitudinal beams will be interrupted.

a. Site 1: Outline Specifications: List of Work

1. Structural

A steel hoistway with external dimensions of 75" x 75" is built down into the void aft of the bow thruster compartment, and up above the upper deck in front of the house. A recessed walkway is built into the observation lounge at the level of the foyer, and steps and handrails rearranged. Steps are added as shown on Drawing 8677-A, Sheet 1.

2. Mechanical

The ventilation duct located approximately 9 ft. port of centerline will need to be rerouted further outboard to clear the elevator trunk. A bilge suction from the elevator pit shall be added to the bilge system.

3. Electrical

The power cable running to the forward container refrigeration plug on the starboard side shall be recoiled back to the wire tray at Frame 13 and rerouted around the forward side of Frame 13, to clear the elevator trunk.

Two power cables, 1 440 VAC 3 phase and 1 120 VAC 1 phase, shall be run from the nearest available distribution panels to the electrical panels for the elevator.

b. Unresolved Questions, Site 1

The forward end of the recessed walkway should be better defined. If wheelchair turnaround is necessary, then the width of the notch should be confirmed. If possible, the notch should be eliminated.

5. Elevator Site 2: Forward End Machinery Casing

This site has the following pros, cons, and basic elements:

- o Estimated Cost: \$179,000
- o Major disruption: Operational. Loading/unloading of truck trailers longer than 28 feet may be prohibited through the starboard side door. Deck operations currently include backing large truck trailers in through the starboard side door, and unloading them forward through the same door. This site would disrupt this operation, either changing the loading method by using the turntable, or eliminating the capability to carry these largest trucks. This site would make the starboard door loading limitations identical to the port door loading limitations.
- o About six seats in the forward observation lounge are lost, but two are added next to the elevator.
- o There is excellent access at the main deck.
- o The hoistway at the main deck will interfere with the 2 foot overhang of trailers on the turntable.
- o Loading of long trailers (45') through the starboard door, which formerly could be loaded at Haines, Skagway, Juneau, Sitka, Petersburg, Hollis, Ketchikan, and Auke Bay, will probably not be possible.
- o The pit location is good, however a manhole must be relocated.

a. Site 2: Outline Specification: List of Work

1. Structural

A hoistway with 75" x 75" external dimensions is built down into the void space between Frames 33 and 36. A full 8 feet is used as the pit, allowing ample room for elevator machinery. Part of the bulkhead at the aft end of the observation lounge is removed, the floor is lowered, and the steps relocated forward, as shown on Drawing No. 8677-A, Sheet 2.

2. Mechanical

The ventilation supply terminal between Frame 31 and 35 for the upper deck shall be shortened approximately 4 ft. and the supply duct to the terminal rerouted forward of the elevator trunk.

In the main deck overhead, the head exhaust duct and the main deck ventilation ducts shall be rerouted around the elevator trunk and deck modification.

The drain piping from the men's upper deck head and the main drain line shall be rerouted around the elevator trunk and deck modification.

COST ESTIMATE: ELEVATOR SITE NO:1

THE GLOSTEN ASSOCIATES, inc.
Naval Architects - Marine Engineers - Ocean Engineers

BY DL	JOB NO 8677
DATE 11-17-86	SHEET 1 OF 1

ITEM	SYSTEM	DESCRIPTION	QUANTITY	UNIT WEIGHT	UNIT LABOR	UNIT MAT'L.	TOTAL WEIGHT	TOTAL LABOR	TOTAL MATERIAL	REMARKS
		ELEVATOR INSTALLATION								
		OPTION 1								
		REMOVE INTERFERENCES	104 HR		\$ 35/HR			\$ 3640	\$ 200	
		EXCESS UPPER DECK FOR WALKWAY	518 HR		\$ 35/HR			18130	5500	
		FABRICATE & INSTALL ELEVATOR TRUNK	850 HR		\$ 35/HR			29750	6000	
		INSTALL ELEVATOR, HOOK-UP & TEST	720 HR		\$ 35/HR			25200	1000	
		FABRICATE & INSTALL FAIRING - UPPER DK	120 HR		\$ 35/HR			4200	800	
		PREPARE & PAINT SURFACES	112 HR		\$ 35/HR			3920	2000	
		REINSTALL INTERFERENCES	76 HR		\$ 35/HR			2660	-	
		SUB-TOTALS	2500 HR					\$ 87500	\$ 15500	
		ELEVATOR & ACCESSORIES							90000	
		10% CONTINGENCY						8750	10550	
		TOTAL						96250	116050	= \$ 212,300

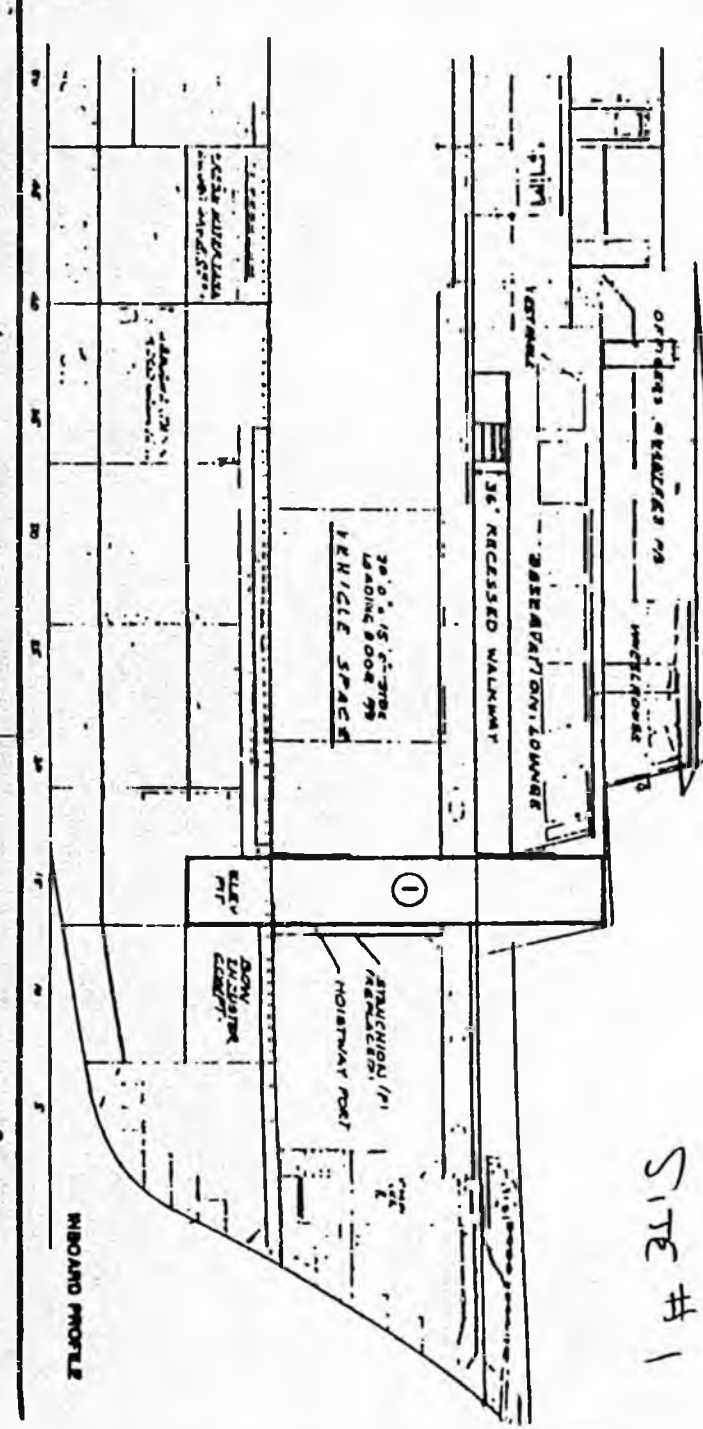
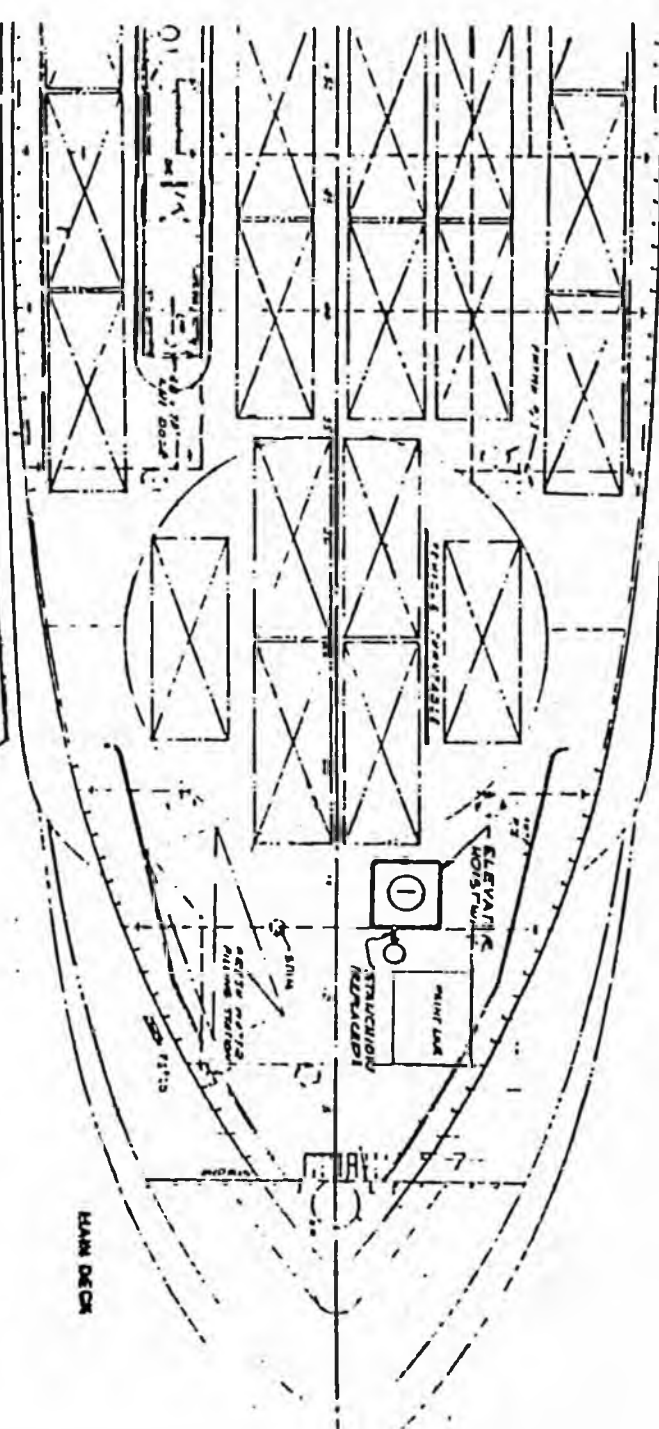
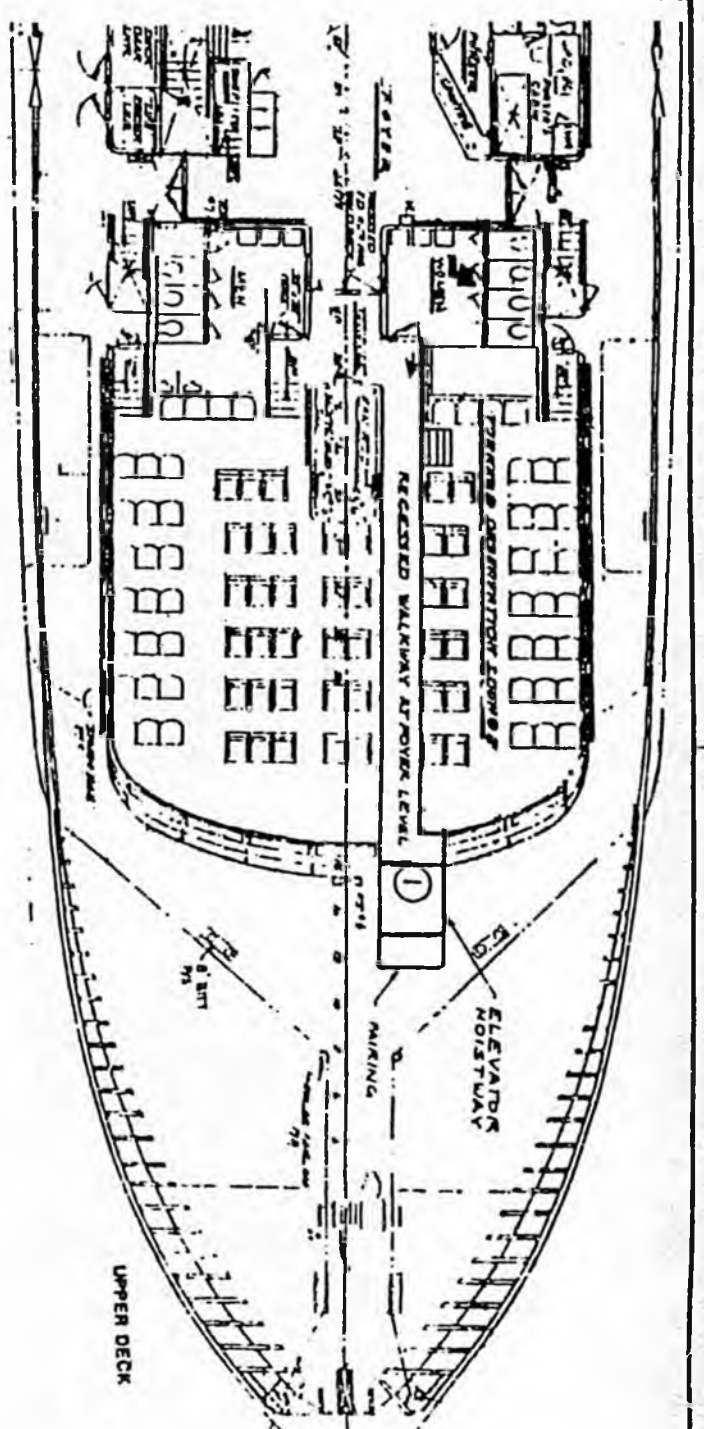

SITE # 1

WARD PROFILE

A B C D

01 02 03 04 05 06 07 08 09 10 11 12 13 14 15 16 17 18 19 20 21 22 23 24 25 26 27 28 29 30 31 32 33 34 35 36 37 38 39 40 41 42 43 44 45 46 47 48 49 50 51 52 53 54 55 56 57 58 59 60 61 62 63 64 65 66 67 68 69 70 71 72 73 74 75 76 77 78 79 80 81 82 83 84 85 86 87 88 89 90 91 92 93 94 95 96 97 98 99 100

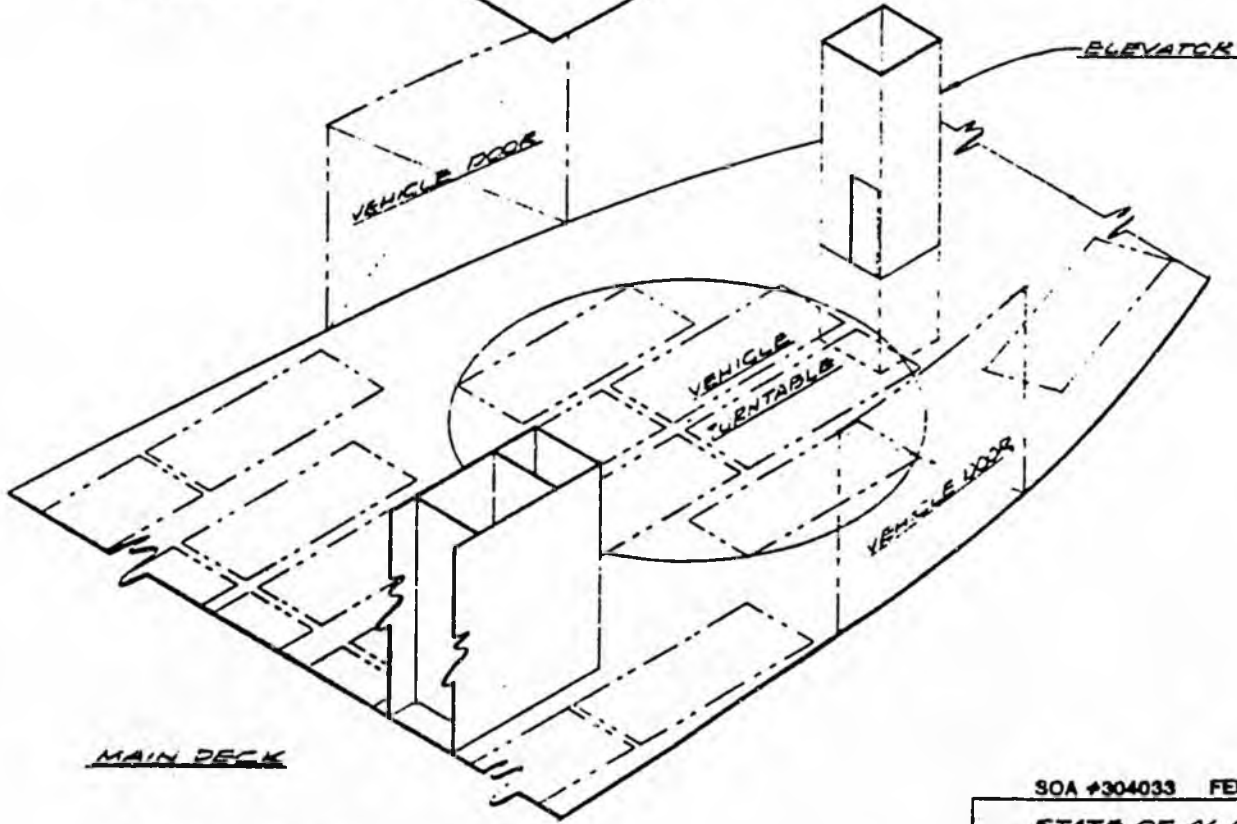
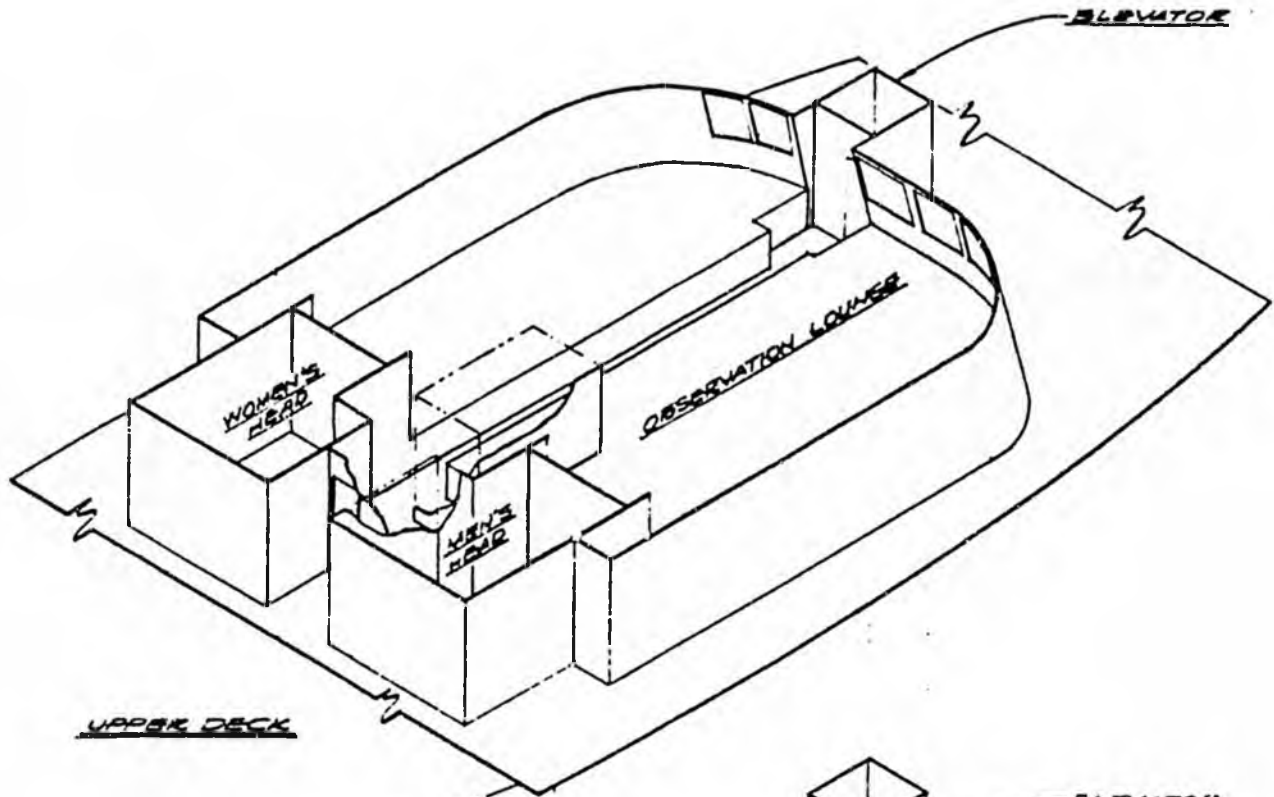

SITE # 1

SOA #304033 FED. #F-9500(13)

STATE OF ALASKA AMHS

MIV LEGONTE
MODIFICATIONS

ELEVATOR ARRAYS & PERSPECTIVE
SITE 1: EWR OBSERVATION LOUNGE

THE GLOSTEN ASSOCIATES, INC.
CONSULTING ENGINEERS SERVING THE MARINE COMMUNITY
625 Main St. Suite 1000 - 625 First Avenue - Seattle, Washington 98104-2224



Drawn By	Date	Checked By	Date	Approved By	Date
CARONK	11/18/80	WLM	1/19/81	WLM	1/19/81
Scale	Drawing No.		Rev.		
1/8"=1'-0"	8677-A		Sheet 1 of 4		

A bilge suction from the elevator pit shall be added to the bilge system.

Two hot water heating lines at Frame 33 in the main deck overhead shall be rerouted aft around the elevator trunk and deck modification.

3. Electrical

Two power cables, one, 440 VAC 3 phase and one 120 VAC 1 phase, shall be run from the nearest available distribution panel to the electrical panels for the elevator.

b. Unresolved Questions, Site 2

The actual truck loading and unloading method with the proposed elevator in place, should be determined.

COST ESTIMATE : ELEVATOR SITE NO:2

THE GLOSTEN ASSOCIATES, inc.
 Naval Architects · Marine Engineers · Ocean Engineers

BY DL	JOB NO 8677
DATE 11-18-86	SHEET OF 1

ITEM	SYSTEM	DESCRIPTION	QUANTITY	UNIT WEIGHT	UNIT LABOR	UNIT MAT'L.	TOTAL WEIGHT	TOTAL LABOR	TOTAL MATERIAL	REMARKS
		ELEVATOR INSTALLATION								
		OPTION 2								
		REMOVE INTERFERENCES	96 HR		\$35/HR			\$3360		
		LOWER UPPER DECK TO FOYER LEVEL	154 HR		\$35/HR			\$5390	\$800	
		FABRICATE & INSTALL ELEVATOR TRUNK	770 HR		\$35/HR			\$26950	\$5400	
		INSTALL ELEVATOR HOOK UP & TEST	720 HR		\$35/HR			\$25200	\$1000	
		PREPARE & PAINT SURFACES	64 HR		\$35/HR			\$2240	\$1000	
		REINSTALL INTERFERENCES	32 HR		\$35/HR			\$1120	\$200	
		SUB-TOTALS	1836 HR					\$64260	\$8400	
		ELEVATOR & ACCESSORIES							\$90,000	
		10% CONTINGENCY						\$6426	\$840	
		TOTAL						\$70686	\$108,240	= \$178,926

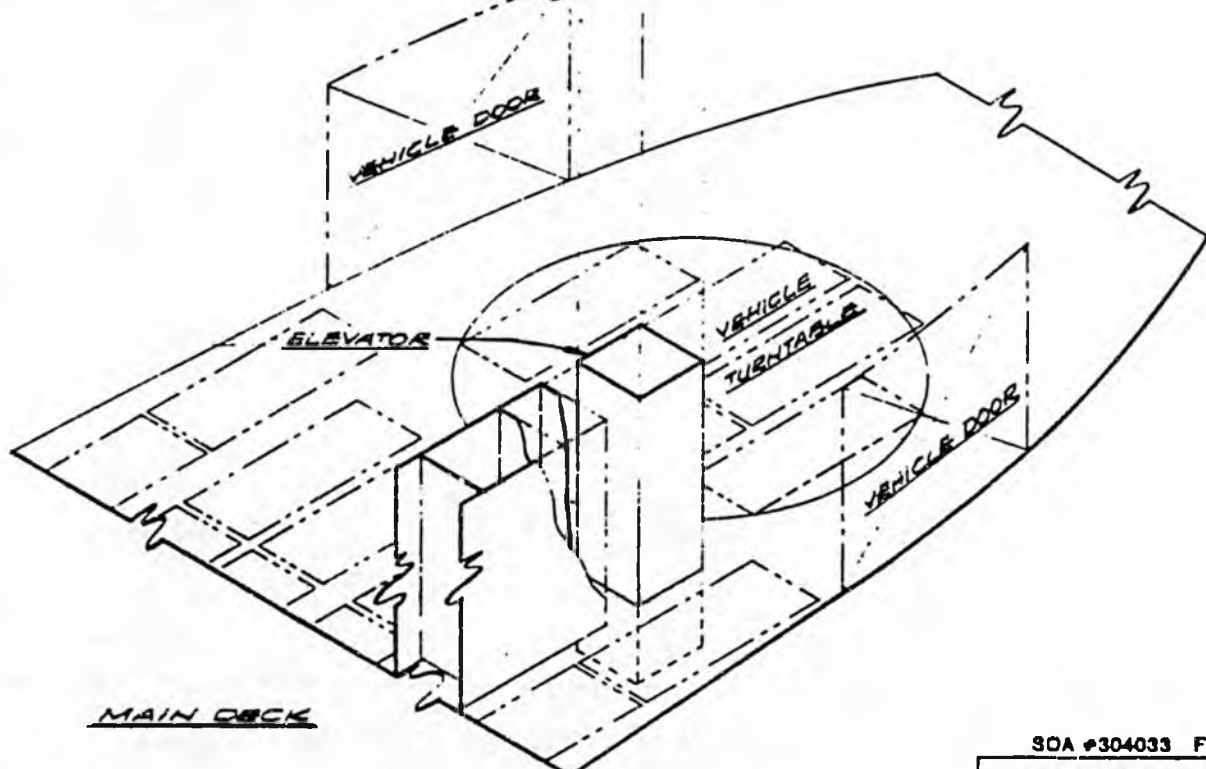
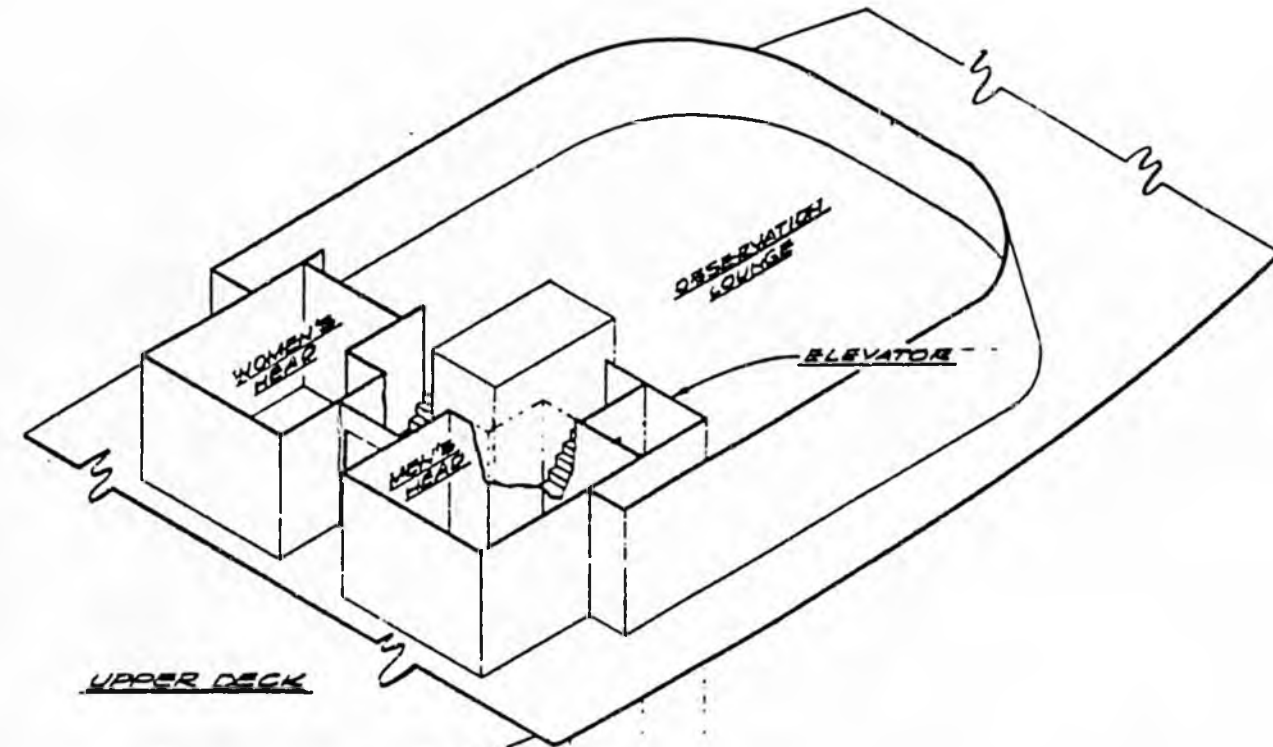

SITE #2

SOA #304033 FED. #F-9500(19)

STATE OF ALASKA AMHS

M/V LACONIA
MODIFICATIONS

ELEVATOR ARRAYS & DEFECTIVE
SITE #1 END AND MACH'Y CABINE

THE GLOSTEN ASSOCIATES, INC.
CONSULTING ENGINEERS SERVING THE MARINE COMMUNITY
225 MARINE BUILDING • 225 FISH MARKET • SEASIDE, WASHINGTON 98134-2724

Drawn by	Date	Checked by	Date	Approved by	Date
CAC/CH	1/20/80	WJH	1/20/80	WJH	1/20/80
Scale	Drawing No.		Rev.		
1/8" = 1'-0"	8677-A		Sheet 2 of 4		



INBOARD PROFILE

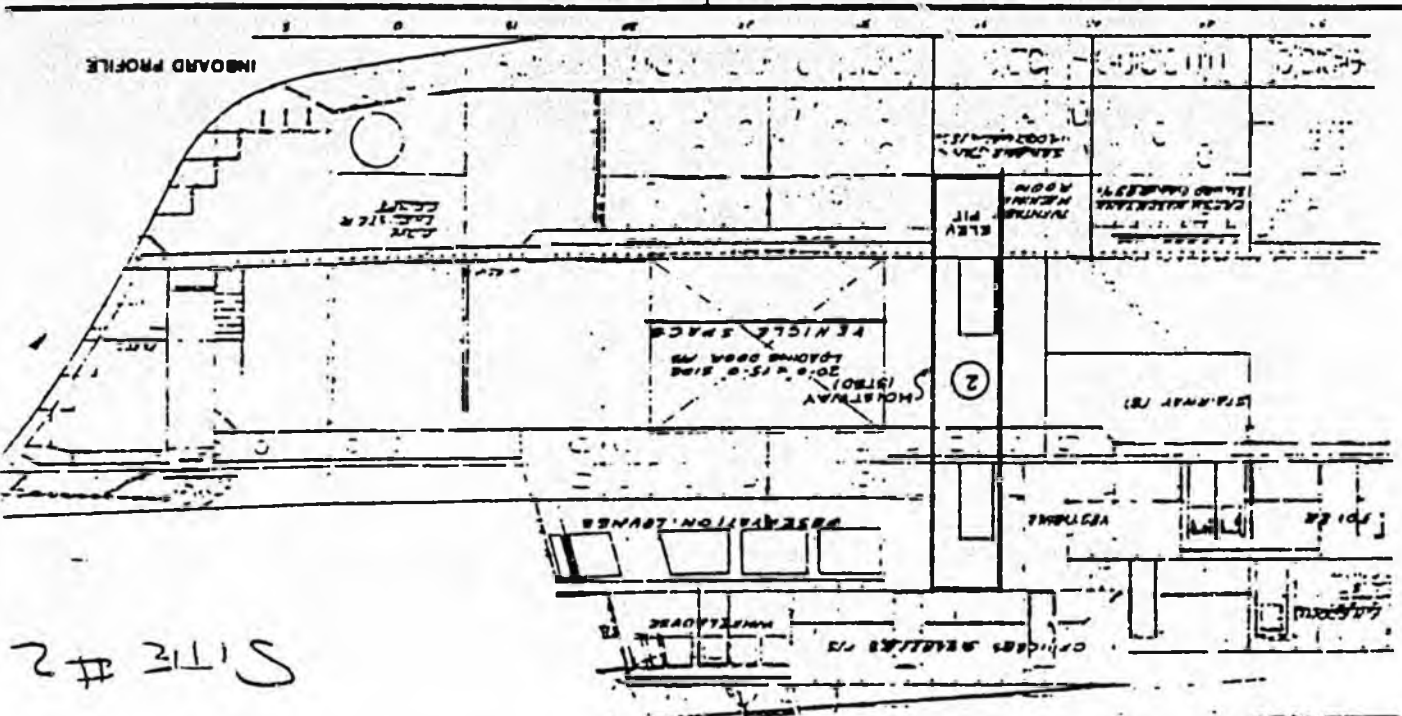

SITE #2

MAIN DECK

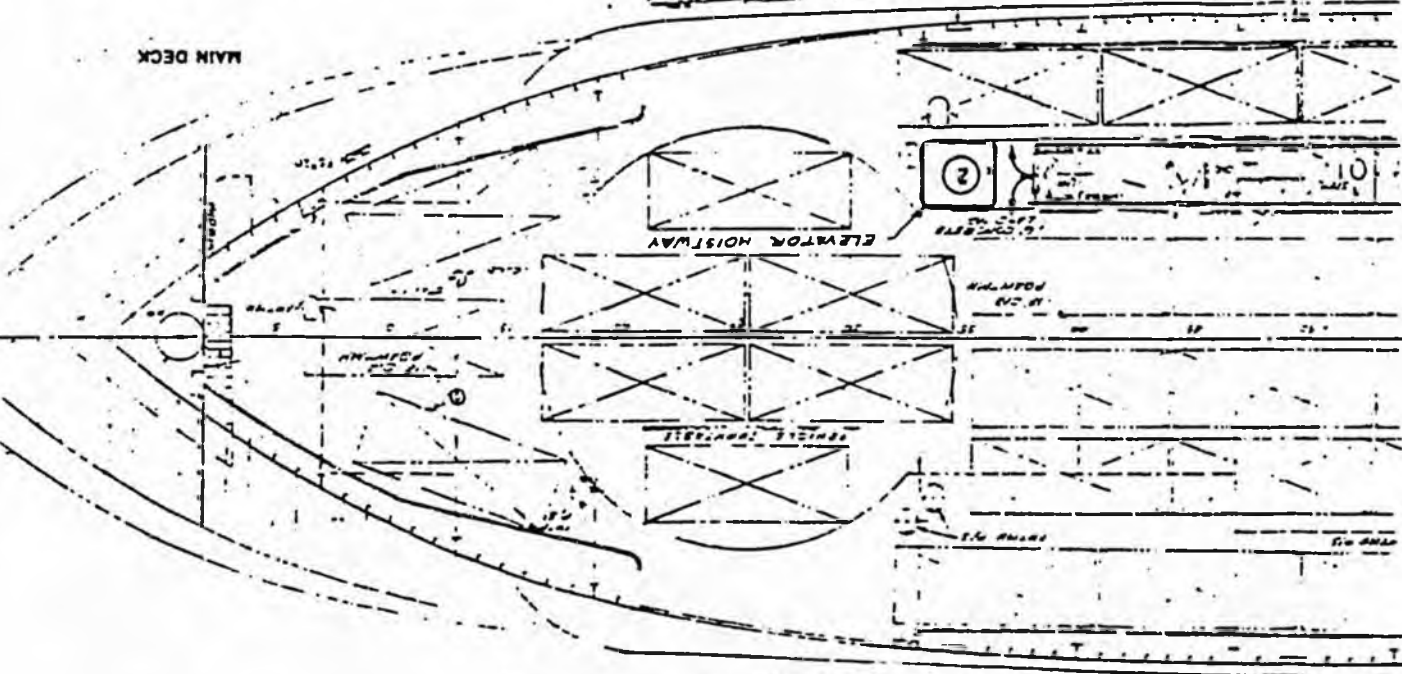

UPPER DECK

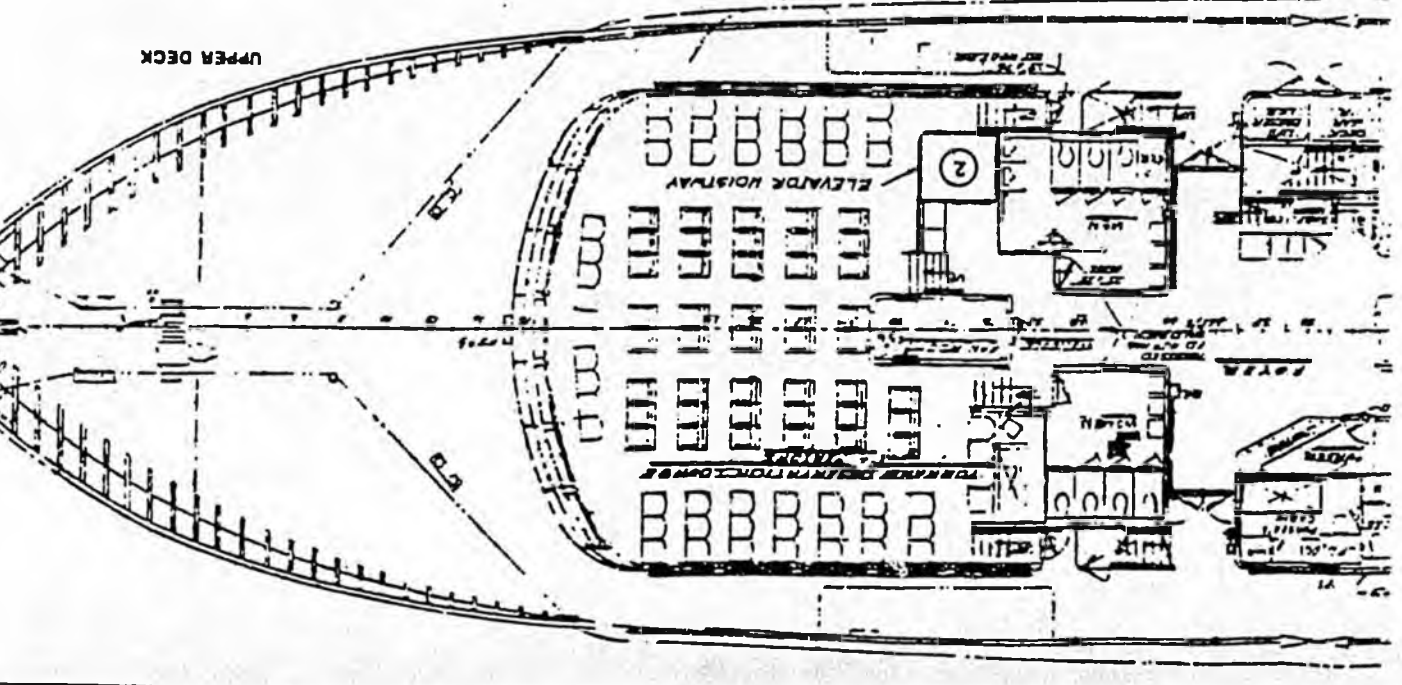

A

B

C

D

6. Elevator Site 3: Port Side

This site has the following pros, cons, and basic elements:

- o Estimated Cost: \$189,000
- o Major disruption: Operational. Loading/unloading autos due to interruption of car lane.
- o One car space is lost from the main deck, and loading and unloading vehicles will be adversely affected.
- o At upper deck, outside walk around becomes restrictive (36" optimistically)
- o Midships lounge gets reduced in size due to relocation of first aid room.
- o The port side access to the outside from forward observation lounge. Access requirements should be O.K.
- o There is no interference with liferaft deployment.
- a. Site 3: Outline Specification: List of Work

1. Structural

A hoistway with 75" x 75" external dimensions is built on the port side between Frames 35-1/2 and 38-1/2, and the existing first aid room is turned into a passageway to the elevator. The aft port side bulkhead of the observation lounge is moved forward slightly, and the outside access is lost. The first aid room is relocated to the forward end of the midships lounge.

2. Mechanical

All ventilation and piping in way of the elevator location shall be rerouted around the elevator trunk.

Fire station number 10 on the upper deck shall be moved 5 ft. aft to the aft bulkhead of the new First Aid room.

The ventilation supply air terminal in the port lounge, upper deck shall have the forward 4 ft. removed. The supply duct for this terminal shall also be modified to provide ventilation air to the new First Aid Room in addition to the lounge. The door shall be undercut to allow for exhaust.

The two ventilation ducts in the overhead of the First Aid Room shall be modified by adding spool pieces where they pass through the new bulkhead at Frame 56-1/2.

Bilge suction from the elevator pit shall be added to the bilge system.

3. Electrical

All electrical wiring or equipment in way of the elevator location shall be relocated or rerouted around the elevator trunk, as necessary.

The light on the upper deck forward lounge port exit shall be removed.

The old First Aid Room lighting shall be modified as required to suit the new arrangement.

The forward two lights in the port side lounge shall be removed and reinstalled in the new First Aid Room on switches.

The T.V. shall be moved aft 5 ft. and rewired.

Two power cables, 1 440 VAC 3 phase and 1120 VAC 1 phase, shall be run from the nearest available distribution panels to the electrical panels for the elevator.

b. Unresolved Questions, Site 3

A new access door to the outside may be necessary, aft in the observation lounge on the port side.

COST ESTIMATE: ELEVATOR SITE NO: 3

THE GLOSTEN ASSOCIATES, inc.
 Naval Architects · Marine Engineers · Ocean Engineers

BY DL	JOB NO 8677
DATE 11-15-86	SHEET 1 OF 1

ITEM	SYSTEM	DESCRIPTION	QUANTITY	UNIT WEIGHT	UNIT LABOR	UNIT MAT'L.	TOTAL WEIGHT	TOTAL LABOR	TOTAL MATERIAL	REMARKS
		ELEVATOR INSTALLATION								
		OPTION 3								
		REMOVE INTERFERENCES	48 HR		\$35/HR			1680		
		RELOCATE FIRST AID ROOM	302 HR					10570	2000	
		FABRICATE & INSTALL ELEVATOR TRUNKS	810 HR					28350	5700	
		INSTALL ELEVATOR, HOOK UP & TEST	720 HR					25200	1000	
		PREPARE & PAINT	14 HR					2240	1000	
		MODIFY ELEVATOR ENTRANCE - UPPER DEK	90 HR					3150	500	
		REINSTALL INTERFERENCES	16 HR					560		
		SUB-TOTALS	2050					71750	10200	
		ELEVATOR & ACCESSORIES							90000	
		10% CONTINGENCY						7175	10020	
		TOTAL						78925	110220	= 189145

ELEVATOR

WOMEN'S HEAD

MEN'S HEAD

OBSERVATION LOUNGE

UPPER DECK

UPPER DECK

VEHICLE DOOR

ELEVATOR

VEHICLE CURTAIN

VEHICLE DOOR

MAIN DECK

MAIN DECK

SITE #3

BOA #304033 FED. #F-8600(13)

STATE OF ALASKA AMHS

M/V LEONTE
MODIFICATIONS

ELEVATOR ARRIS. & PERSPECTIVE
SITE #3: PORT SIDE

THE GLOSTEN ASSOCIATES, Inc.
CONSULTING ENGINEERS SERVING THE MARINE COMMUNITY
800 Valley Lake Building • 525 First Avenue • Seattle, Washington 98104-2224

Drawn By	Date	Checked By	Date	Approved By	Date
CAYONE	10/86	WLH	1/19/86	WLH	1/19/86
Scale	Drawing No.		Rev.		
1/8" = 1'-0"	8677-A		Sheet 3 of 4		

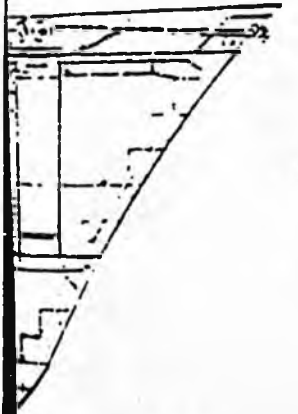
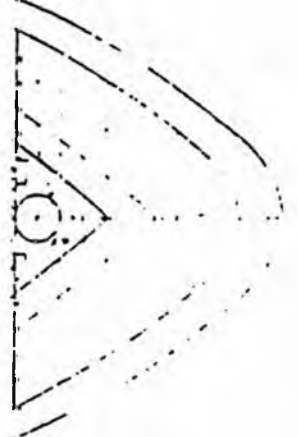
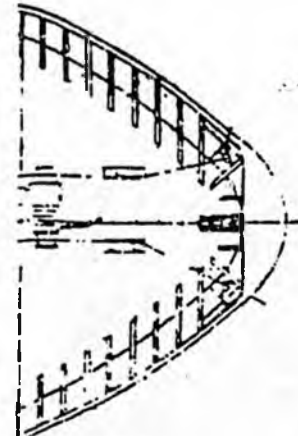

INBOARD PROFILE

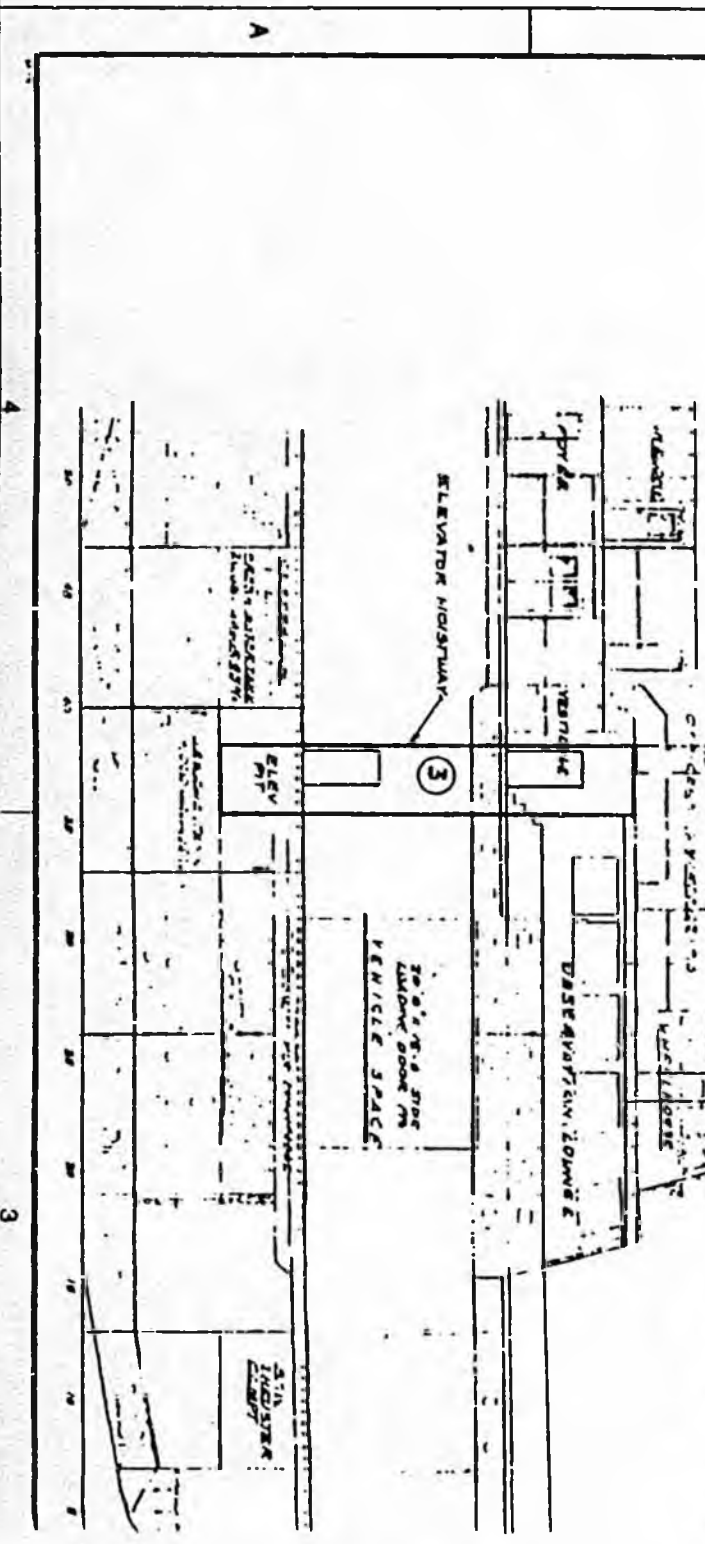
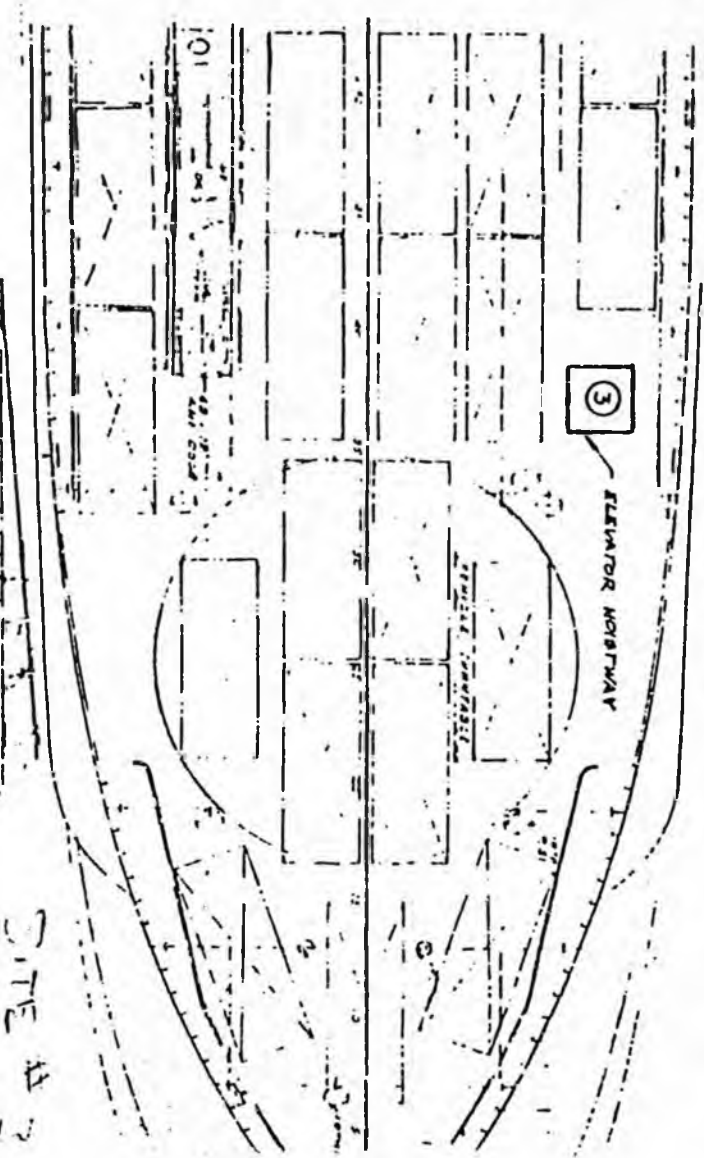
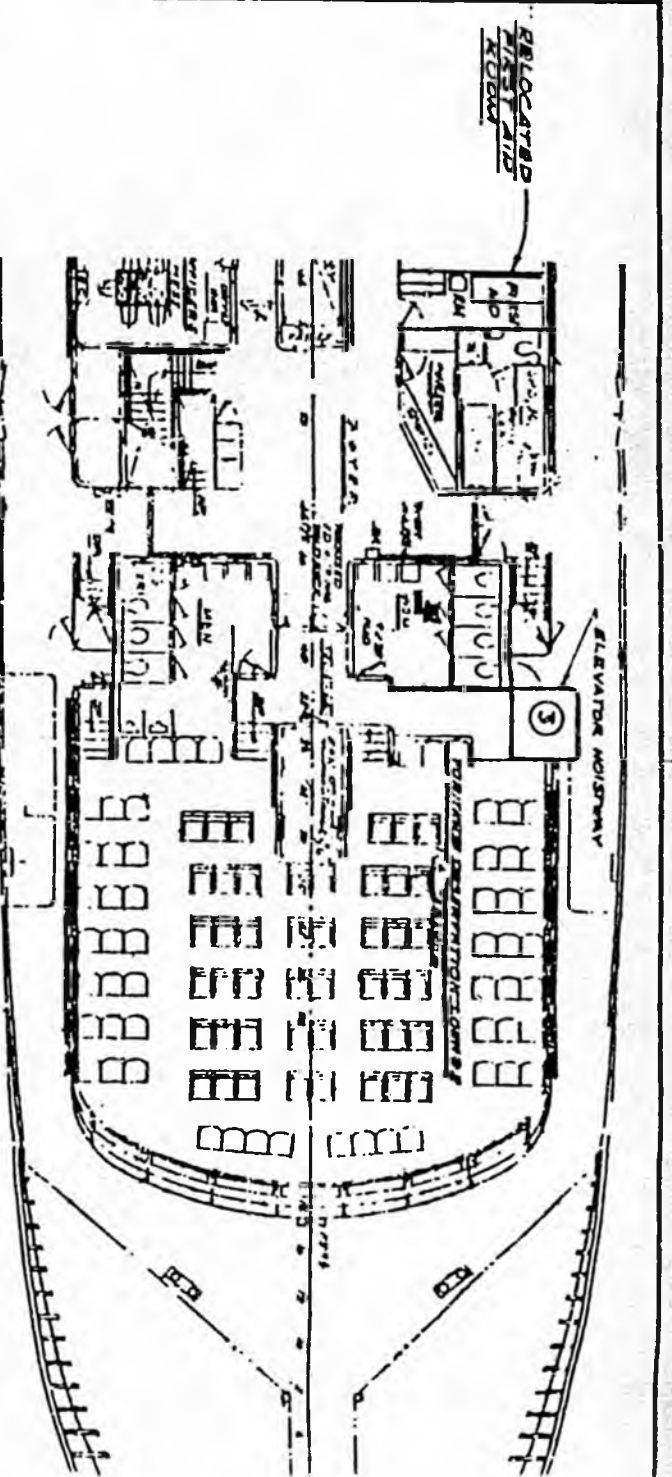

7. Elevator Site 4: Aft Port Corner

This site has the following pros, cons, and basic elements:

- o Estimated Cost: \$208,000
- o Major disruption: Operational. Loading of autos must be altered to keep a 3' wide path to the elevator clear, so that the elevator can be used by passengers boarding and disembarking at stops after the first one. If the elevator was located aft, it would not be responsive to the basic objectives if access to it was blocked at the first stop.

It is important to note that while the general arrangement plans show a 3 foot space between cars, vans and campers are often carried which are wider and reduce this space to one foot. So in reality, maintaining this three foot wide path would surely reduce the available parking area.

- o The stairwell between the main and gallery decks is eliminated.
- o Elevator is distant from primary loading doors.
- o This site would be good for the crew as it is near the refrigerated stores.
- o The life preserver stowage would have to be relocated inboard.
- o This site would be handy for crew use.
- o The life preserver stowage would have to be relocated inboard.
- o Pit location is good.
- o Requires bar to be relocated, so access can be provided into dining area. Dining seating would be lost.
- o Access is very restricted around outside of trunk at the upper deck. Only 24 inches is available.
- o A third level elevator door at the galley deck could be added to provide access to the gallery deck stores space.

a. Site 4: Outline Specifications: List of Work

1. Structural

A hoistway with 75" x 75" external dimensions is built down into the steering gear compartment, and up through the upper deck, possibly above the sundeck level. The stairwell access from the main to gallery deck is removed, and life preserver stow relocated. The bar is relocated, and passage provided between the elevator and dining area.

2. Mechanical

Fire station number 23 and the supply line on the main deck shall be relocated against the inboard side of the elevator trunk at Frame 96.

The hose bibb and supply line on the the main deck at Frame 96 shall be relocated against the inboard side of the elevator trunk.

The drain piping from the upper deck shall be rerouted to the forward side of the elevator trunk.

The freezer on the main deck at Frame 97 port side shall be removed to make room for the elevator.

The hot and cold potable water and the drainage piping systems on the upper deck shall be modified to suit the bar arrangement selected to provide access to the elevator.

A bilge suction from the elevator pit shall be added to the bilge system.

3. Electrical

Power cables on the main deck shall be rerouted around the elevator trunk.

Power shall be provided, in the bar arrangement selected, to operate the undercounter refrigerator, cash register and mixer.

Two power cables, 1 440 VAC 3 phase and 1 120 VAC 1 phase, shall be run from the nearest available distribution panels to the electrical panels for the elevator.

b. Unresolved Questions, Site 4

Access to the gallery deck stores space should be worked out. A new ladder could be provided, if determined necessary.

If the central refrigeration system is included, and this option, the arrangement may change slightly.

COST ESTIMATE: ELEVATOR SITE NO. 4

THE GLOSTEN ASSOCIATES, inc.
Naval Architects - Marine Engineers - Ocean Engineers

BY DL	JOB NO. 8677
DATE 11-18-86	SHEET 1 OF 1

ITEM	SYSTEM	DESCRIPTION	QUANTITY	UNIT WEIGHT	UNIT LABOR	UNIT MAT'L.	TOTAL WEIGHT	TOTAL LABOR	TOTAL MATERIAL	REMARKS
		ELEVATOR INSTALLATION								
		OPTION # 4								
		REMOVE INTERFERENCES	106 HR		35/HR			3710		
		REDO BAR/COFFEE SHOP ARCH'T	652 HR					22820	5100	
		FABRICATE & INSTALL ELEVATOR TRUNK	850 HR					29750	5400	
		INSTALL ELEVATOR, HOOK UP & TEST	792 HR					27720	1100	
		PREPARE & PAINT	64 HR					2240	1000	
		REINSTALL INTERFERENCES	16 HR					560		
		SUB-TOTALS	2180					86800	12600	
		ELEVATOR & ACCESSORIES							90000	
		10% CONTINGENCY						8680	10260	
		TOTAL						95480	112860	= \$ 208,340

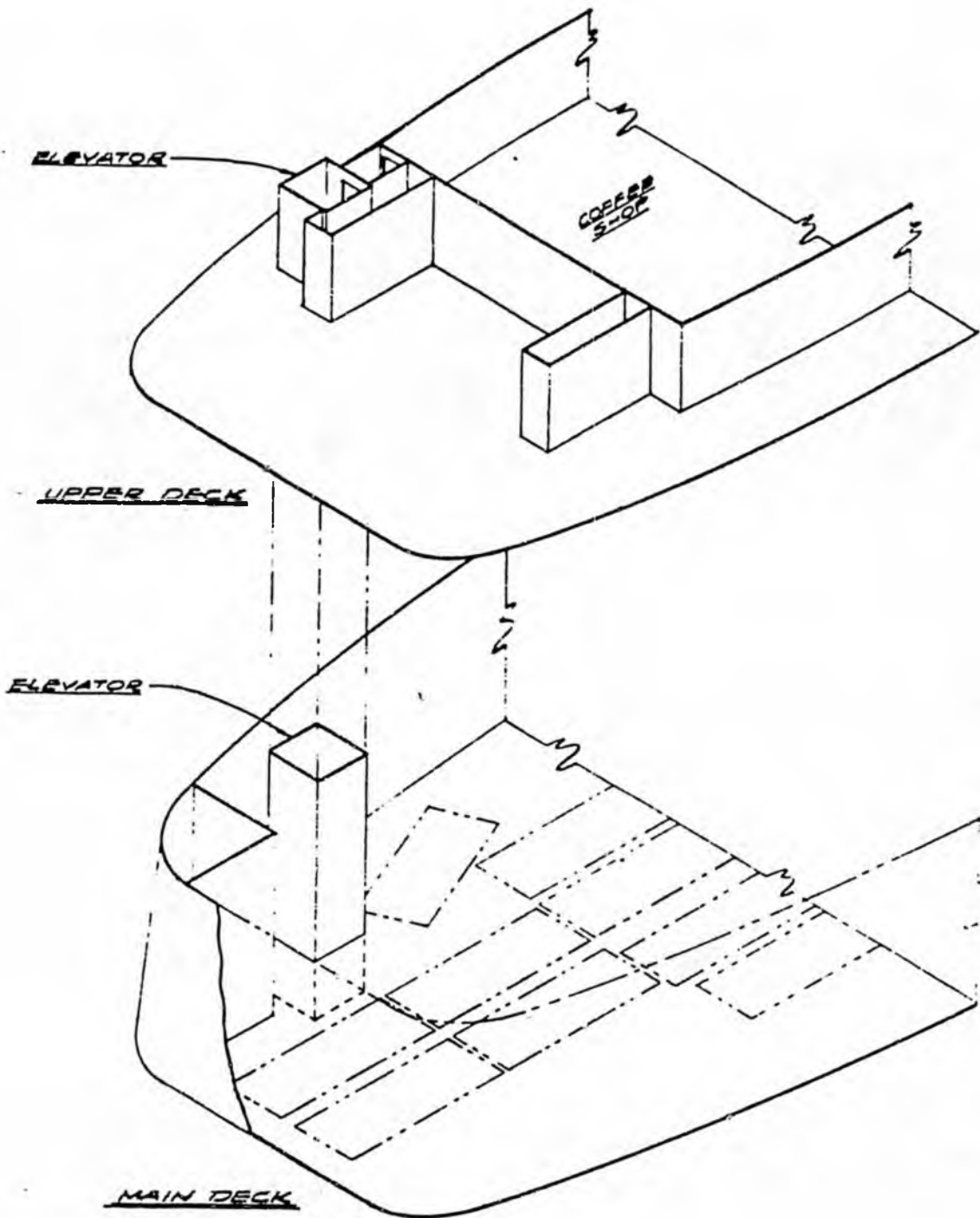

FILE NO. 111-111-111
 DRAWING NO. 111-111-111
 SHEET NO. 111-111-111

SOA #304033 FED. #F-9500(13)

STATE OF ALASKA, AMNS

M/V LACONTE
MODIFICATIONS

ELEVATOR ARRGT. & PERSPECTIVE
SITE 4: AFT PORT CORNER

THE GLOSTEN ASSOCIATES, P.C.
CONSULTING ENGINEERS SERVING THE MARINE COMMUNITY
200 MARINE LIAISON BUILDING • 205 FIFTH AVENUE • SEATTLE, WASHINGTON 98101

Drawn By	Date	Checked By	Date	Approved By	Scale
CAC/CHK	11/18/86	CX/H	11/14/86	WJL/H	1/8" = 1'-0"
Scale		Drawing No.		No.	
1/8" = 1'-0"		8677-A		Sheet 2 of 4	



APPENDIX A

Open Hoistway Elevator, Evaluation & Commentary

Preliminary engineering work was performed by AMHS investigating a non-enclosed hoistway or open hoistway elevator. They investigated 7 locations, which were reviewed and the following comments are presented.

Machinery in the form of either a gear rack or hydraulic cylinder must extend down nearly to the main deck, if not all the way. In order to keep this equipment out of the way, and support it, it can only go down along side a bulkhead, or the machinery casing. This requirement rules out all locations except 'e' and 'g'. AMHS preferred site 'g', as site 'e' took space out of the officers' mess. Site 'g' disrupts the men's head, but provides opportunity to provide a handicap head.

The handicap regulations require a minimum inside dimension of 51" by 54", and the current arrangement shows 32" by 60". This option entails finding additional lavatory space on the vessel, perhaps using the crew and officers head on the upper deck. Despite the rearrangement of heads on the upper deck, site 'g' would be the recommended location.

As discussed in the body of the report, this type of elevator is not recommended. However a letter was sent to the U. S. Coast Guard, inquiring about the approval of this type of elevator. A response is yet to come. This letter and its enclosures follow, and all AMHS correspondence and notes are also included.

A cost for this type of elevator in site 'g' is estimated to be \$131,000. This assumes an equipment cost of about 75% of the equipment in a standard enclosed hoistway type elevator. This assumption may not be conservative, as safety features may be required that are unforeseen at this time.

COST ESTIMATE: ELEVATOR SITE: G

THE GLOSTEN ASSOCIATES, inc.
 Naval Architects Marine Engineers Ocean Engineers

BY DL	JOB NO 8677
DATE 11-19-86	SHEET 1 OF 1

ITEM	SYSTEM	DESCRIPTION	QUANTITY	UNIT WEIGHT	UNIT LABOR	UNIT MAT'L.	TOTAL WEIGHT	TOTAL LABOR	TOTAL MATERIAL	REMARKS
		ELEVATOR INSTALLATION								
		OPTION 'G'								
		REMOVE INTERFERENCES	64 HR		35/HR			2240	300	
		MODIFY RESTROOMS	142 HR					4970	2600	
		INSTALL ELEVATOR TRAILER	200 HR					7000	1000	
		INSTALL ELEVATOR & ACCESSORIES	720 HR					25200	1000	
		PREPARE & COAT DISTURBED SURFACES	40 HR					1480	800	
		REINSTALL INTERFERENCES	64 HR					2240		
		SUB-TOTAL	1230 HR					43330	5700	
		PURCHASE ELEVATOR & ACCESSORIES							70000	
		10% CONTINGENCY						4333	7570	
		TOTAL						47663	85270	= \$ 130,933



THE GLOSTEN ASSOCIATES, inc.

CONSULTING ENGINEERS SERVING THE MARINE COMMUNITY

600 Mutual Life Building • 605 First Avenue
Seattle, Washington 98104-2224

Phone: 206-624-7850
Telex: 882053

15 November 1986
File No. 8677

VIA TELECOPIER

Commanding Officer
U. S. Coast Guard
MSC (g-MSC-1)
Hull Division
2100 2nd Street Southwest
Washington, D.C. 20593

Subject: Non-enclosed-hoistway elevators for vehicle/passenger ferries.
Alaska Marine Highway System
M/V LeCONTE, O.N. 555-601

Gentlemen:

We are currently exploring options for the installation of a personnel elevator on board the subject vessel. The elevator will serve passengers, and travel between the main deck (auto deck) and upper deck (passenger deck). The elevator will be operated at dockside only; not while underway.

In order to minimize the impact of the installation on the main deck arrangement, an elevator with a non-enclosed hoistway is being considered. We recognize this approach is not typical, but respectfully request your review of the information in this letter and on the enclosed sketches, and we solicit your comment as to the feasibility of approving such an installation.

You will notice in the enclosed sketches that the upper deck is penetrated by the upper end of the hoistway, and this box structure would be a fire boundary as required for the overhead of the car deck. One wall of this box structure would have fire doors for access in and out of the elevator car. We note however that when the car is not at the upper deck level, while being used dockside, the box structure would be open on the bottom.

We compare the box structure to the penetration of a stairwell above the main deck. We further note that while there is no door at the bottom of the box structure, as there is at the bottom of a stairway, there also is no enclosed hoistway. This elevator would not be used during fire and would not need to be considered a "safe haven", like a stairwell.

Commanding Officer
14 November 1986
Page II

We would appreciate a quick response to this inquiry, and would like to call next Tuesday to discuss any first impressions you may have.

Thank you for your attention to this matter, and please call with any questions, or if clarification of the enclosed sketches is needed. Also, since we sent the sketches by telecopier, please call if you can't read them and we will send better copies by courier.

Yours very truly,

THE GLOSTEN ASSOCIATES, INC.

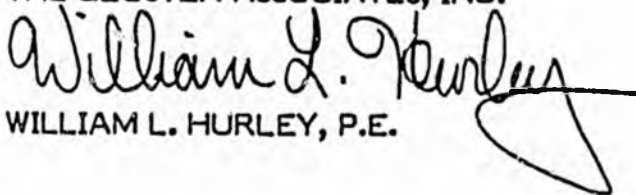

WILLIAM L. HURLEY, P.E.

WLH:ap

Enclosures: (all 8-1/2 x 11 sheets)

1. LECONTE Proposed Elevator, Main Deck Illustrations, 1 sheet.
2. LECONTE Proposed Elevator, Elevation and Upper Deck Plan View, 1 sheet.
3. LECONTE Elevation, 1 sheet.
4. LECONTE Main Deck Arrangement, 1 sheet.
5. LECONTE Gallery Deck Arrangement, 1 sheet.
6. LECONTE Upper Deck Arrangement, 1 sheet.

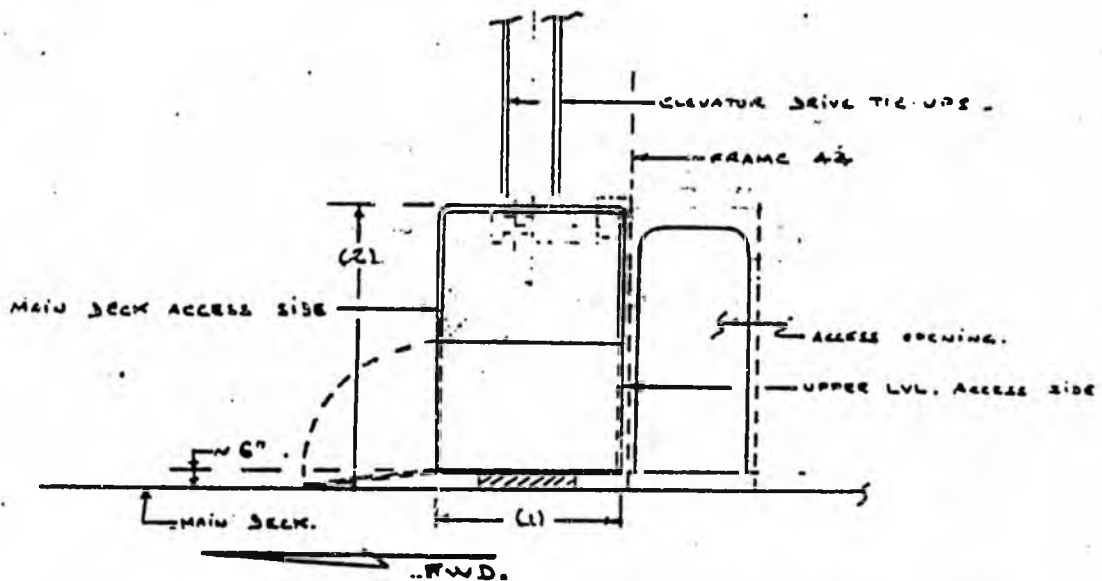
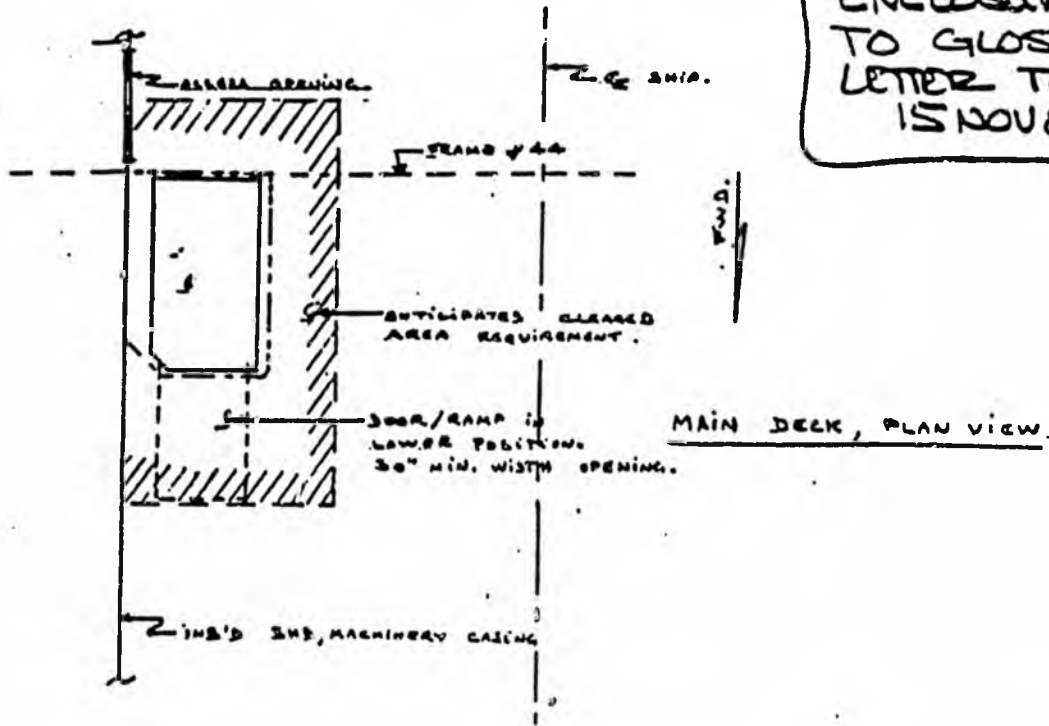
ENCLOSURE 1
 TO GLOSTON
 LETTER TO MSC,
 15 NOV 86



PROFILE ELEVATION, FROM CENTERLINE
LOOKING TO STARBOARD.

LA CONTE / AURORA - PROPOSED ELEVATOR,
MAIN DECK LVL. ILLUSTRATIONS.

~~DATE~~
 JUNEAU, AUG. 26.

- (1). APPROXIMATELY 5'4" MAX. OUTSIDE DIM.
- (2). APPROXIMATELY 7'8" MAX. AVAILABLE TO CLEAR OVERHEAD BEAMS IN THE UPPER POSITION.

ENCLOSURE 2
 TO GLOSTEN
 LETTER TO NISC,
 15 NOV 86

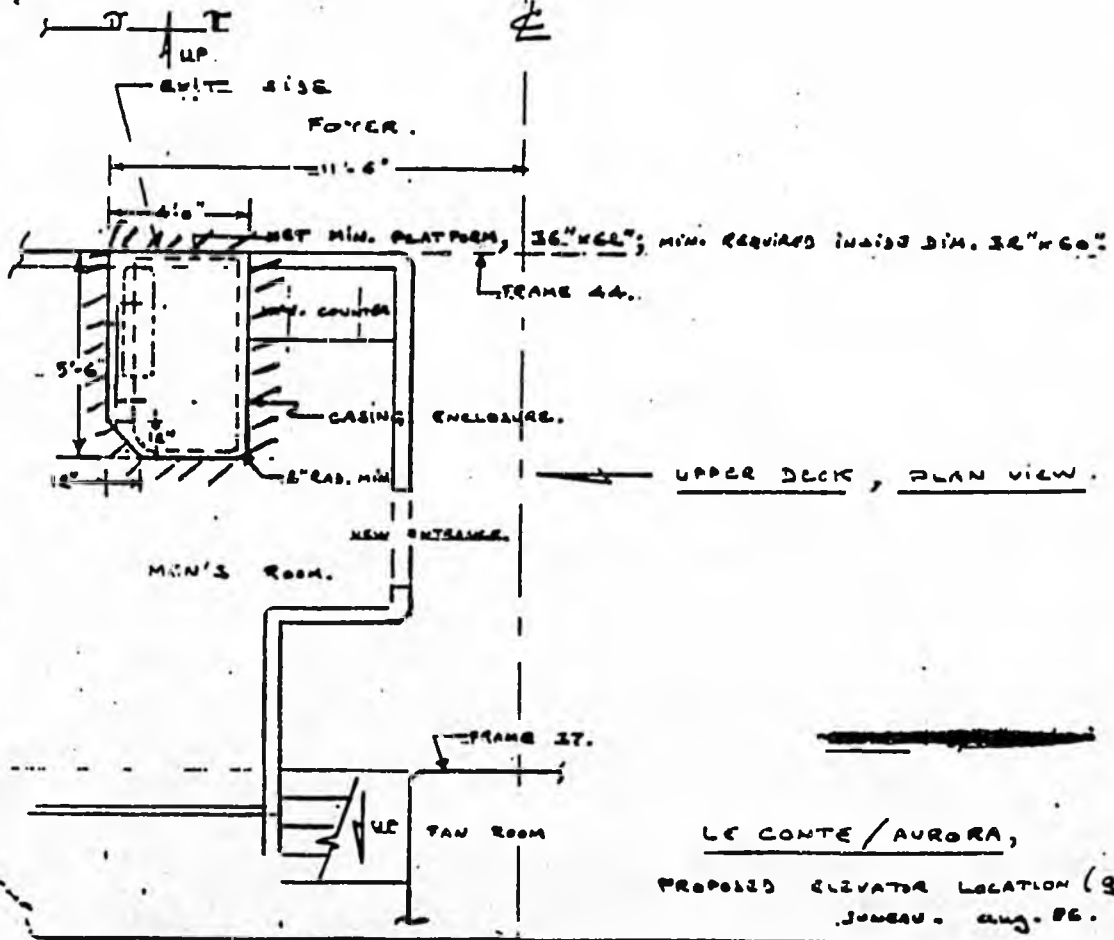
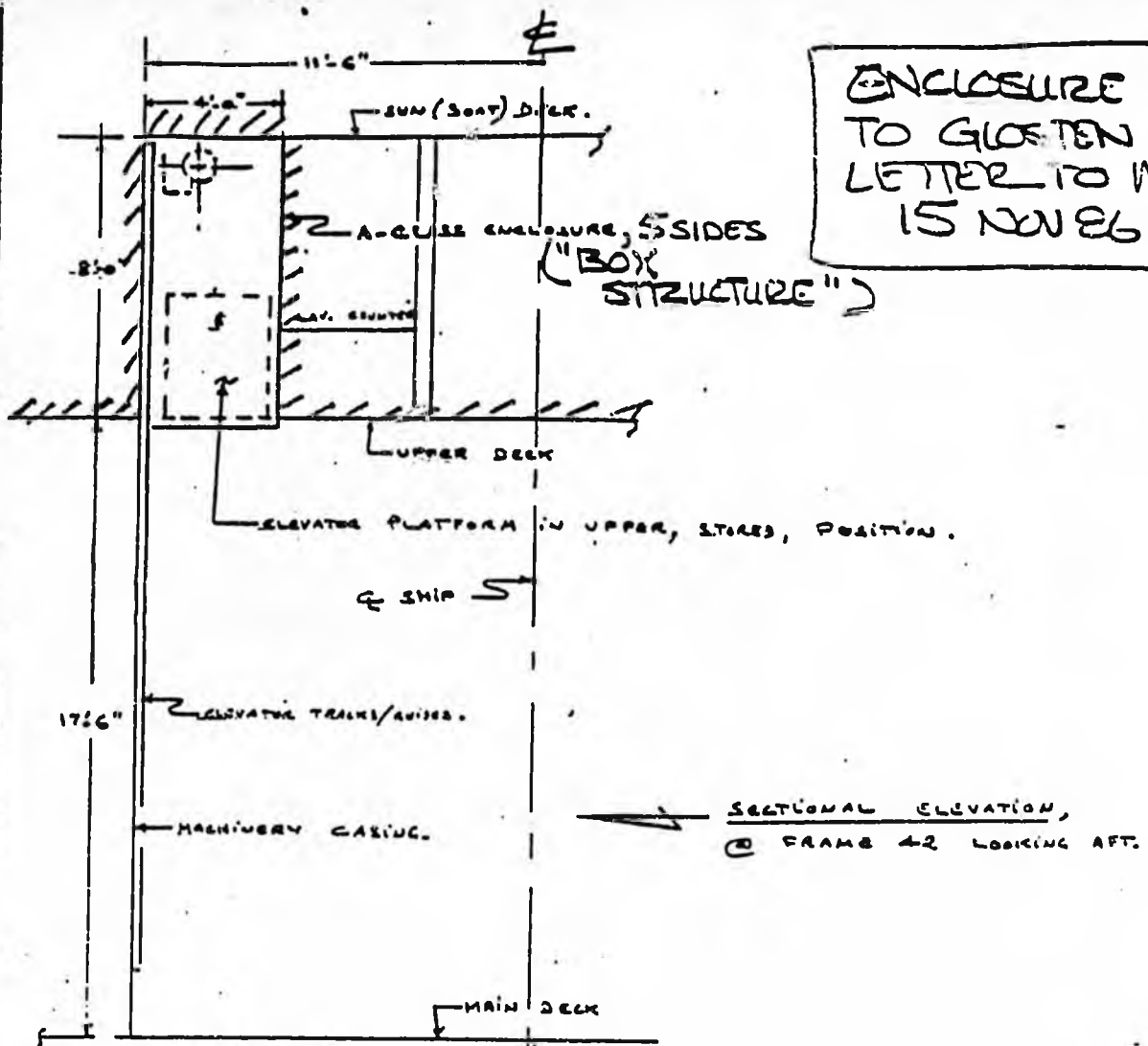

LE CONTE / AURORA,
 PROPOSED ELEVATOR LOCATION (3)
 JUNEAU. AUG. 86.

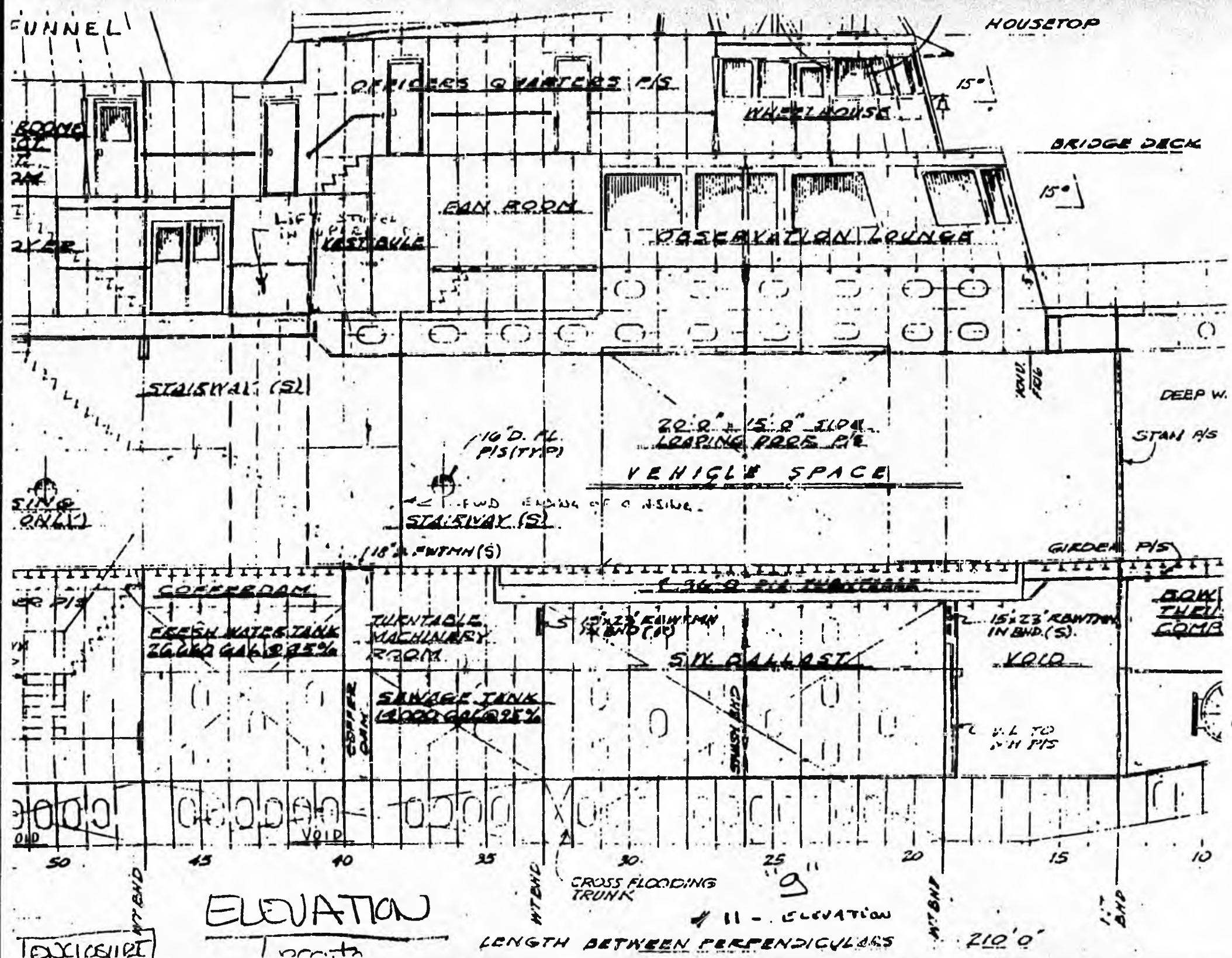

VEHICLE 2A
15'0" x
20'0" x

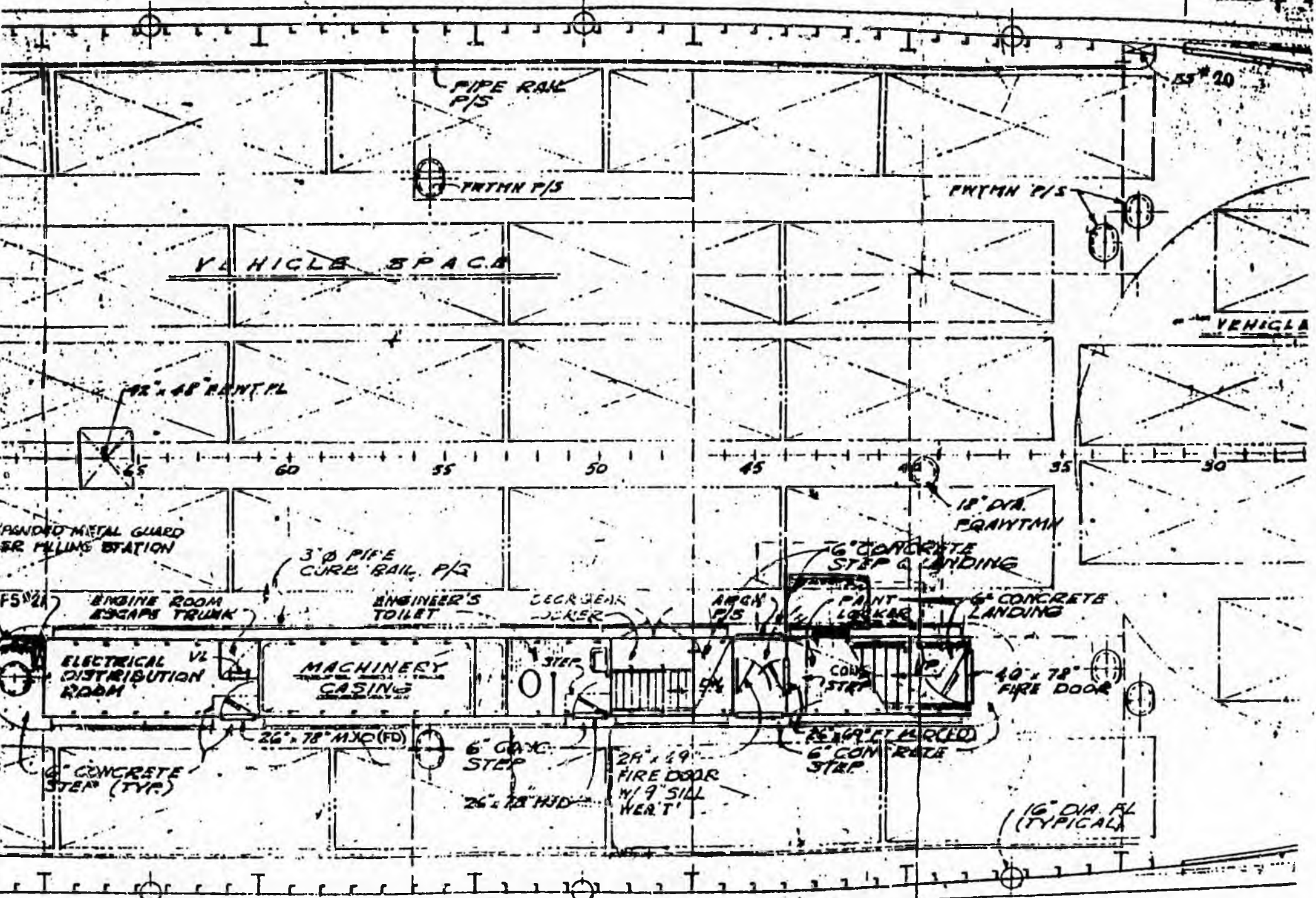

Enclosure 4

MAIN DECK ARRGT

9" # 11-A - MAIN DECK 'LVE'

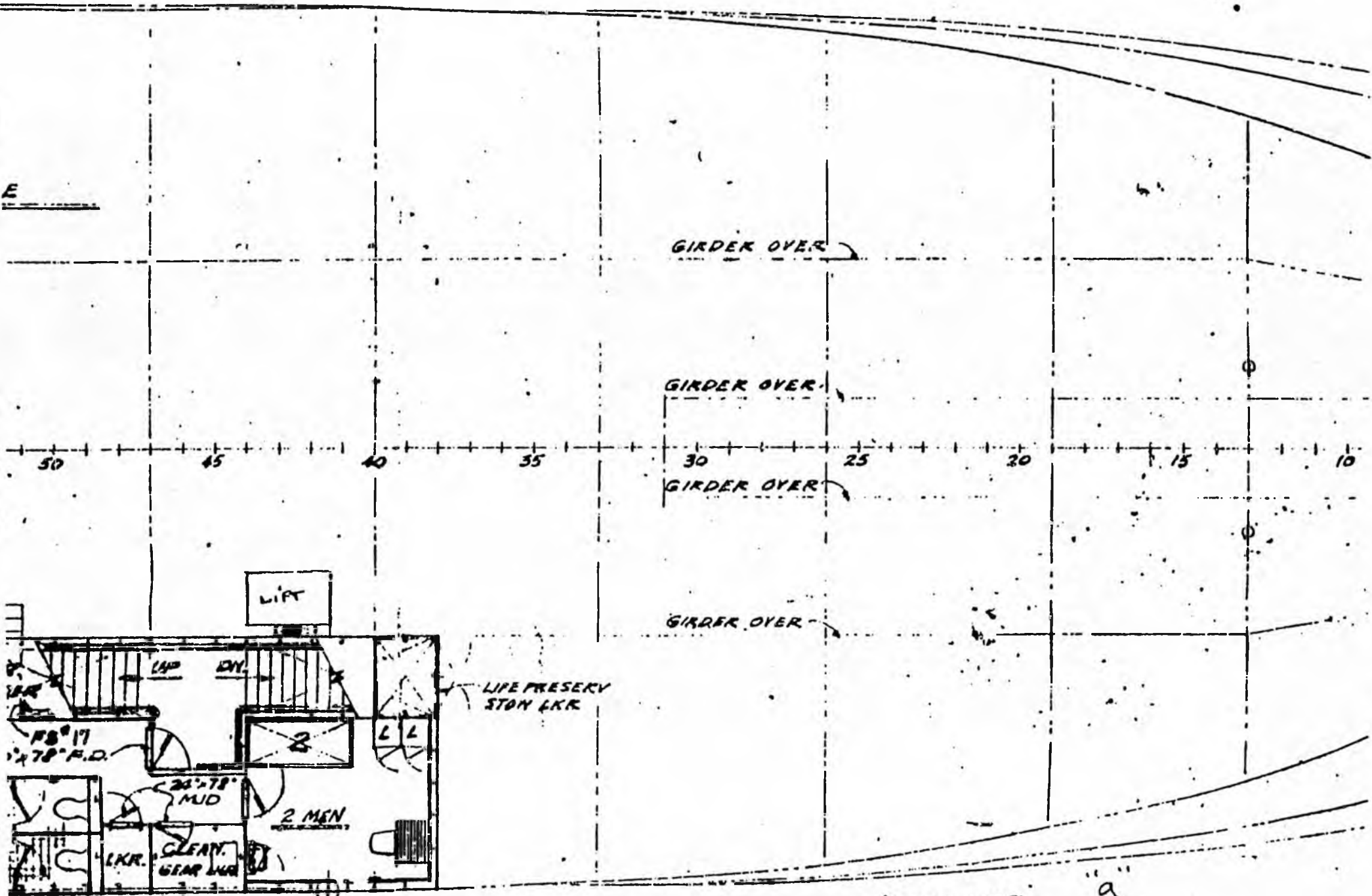

1. (ENCLOSURE) GALLERY DECK # 11 B. GALLERY DECK. LEVEL. ADD'G

9

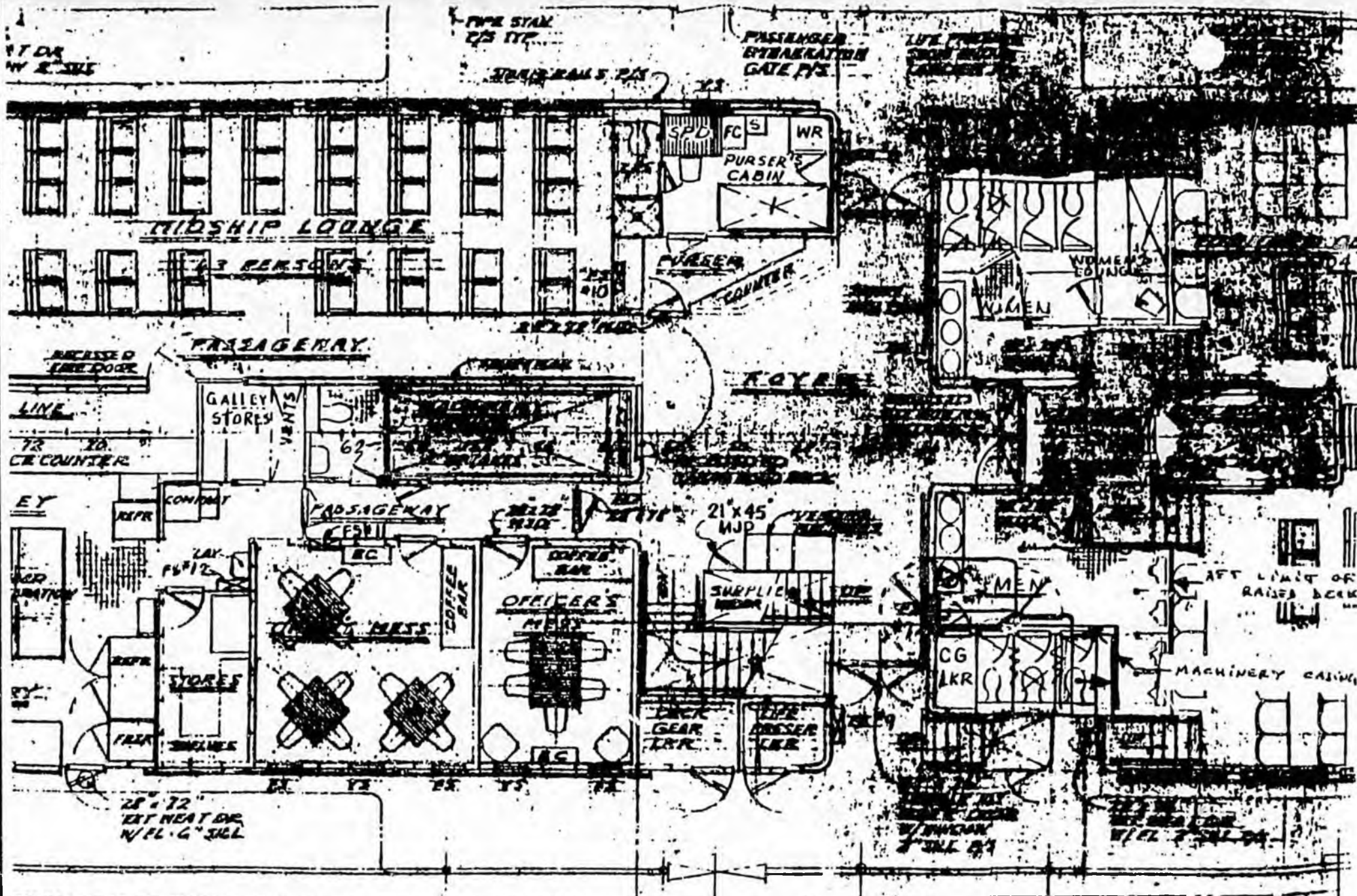

ENCLOSURE
6

UPPER DECK ARRANGEMENT

SCALE 1" = 1'-0"

MXX 9 #11C-UPPER DECK LVL

PURSUIT OF AUGUST 20, 1986 INQUIRY

On September 3 and 4 we contacted the elevator manufacturers of the attached list to obtain their comments on "our submitted input" of August 20.

No. 3 had already answered by letter, returning the file and confirming their inaptitude to supply the type of equipment required.

The answers from suppliers 1, 2, 4, and 5 are all somewhat containing the same message.

- The proposed installation does not meet recognizable code.
- They have enough business without dealing with special headache projects.
- Cannot be of any help, have to decline, or cannot do anything for us.
- They do not produce the type of hardware required and cannot adapt...

Potential supplier No. 6 showed definite positive but cautious interest. They sent us a copy of applicable code. In discussions their speaker acknowledges the possibility of using a rack and pinion drive and recognize it as a most compact drive system. He also mentions that they would have no problem to incorporate the standard safety features as "overspeed", "emergency power" etc., on this type of drive.

On September 5 we rechecked with Mr. Ken Schoenlein of Crane UNIDYNAMICS. Without being worded it appears that the slow response is also due to at least certain hesitations on the subject of safety without an elevator shaft; Realizing that the alternate operational functions are somewhat arbitrary in approval and possibly restrictive in operations. I have been promised a written answer on the subjects (see September 16 letter). Otherwise K.S. feels that Crane UNIDYNAMICS could comply with the geometric restrictions, but the comment is made without having done a detailed review of the material sent by AMHS. (This report was written around September 10).

dmd/075/diry2

Rec ID CO
address1 _____ address2 _____
city _____ state _____
zip _____
attn _____

1 Schindler Haughton
Elevators & Escalators 1123 N.W. 51 Street
Seattle WA
98107
Attn: John Albrecht

2 Montgomery Elevators
1207 Westlake Avenue North
Seattle WA
98109
Attn: Tom Olmsted

3 Westinghouse Elevator Co.
6150 6th Street P.O. Box 80984
Seattle WA
98108
Attn: Tony Weiss

4 U.S. Elevator
2920 N.E. Blakeley Street
Seattle WA
98105
Attn: Bob Dempsey

5 Otis Elevator
3161 Elliott Avenue Suite 220
Seattle WA
98121
Attn: Rick Lewis

6 American Elevator Co.
1258 1st Avenue South
Seattle WA
98134
Attn: Marc Vendetti

7 Crane Unidynamics
10616 Trenton
St. Louis MO
63132
Attn: Ken Schoenlein, Manager

CRANE

UNIDYNAMICS

A SUBSIDIARY OF CRANE CO

UNIDYNAMICS/MIDWEST

10610 TRENTON

ST. LOUIS, MO 63132

16 September 1986

Mr. George Diry
P.O. Box 116
Douglas, AK 99824

Subject: Handicap Personnel Elevator for Car Ferry

Reference: P6-2113

Dear Mr. Diry:

After reviewing your comments and illustrative sketches, we feel that a hydraulic elevator may better suit your application than the originally suggested rack and pinion system. Due to the extremely low overhead clearance between the upper and sun decks, there is insufficient room for a rack and pinion type system which requires the drive machinery and safety assembly to be mounted above the elevator on the machinery frame. This system normally requires 13 feet of space between the upper landing and the underside of the overhead. By reducing the inside car height, adjusting the spacing on equipment mounted to the machinery frame and keeping overtravels to a minimum, it is possible to squeeze the elevator into an 11'-6" vertical space. With only 7'-8" of room available, a rack and pinion unit is not practical.

A hydraulic elevator on the other hand, would allow a full 84" inside height for the elevator. The lift cylinder would be positioned behind the elevator and between the bulkhead mounted guide rails. The hydraulic power supply and reservoir could be located in an adjacent area to prevent it from being in a high traffic area.

Nevertheless, as we see it, any elevator that is installed in the area that you have designated is going to be violating certain ANSI/ASME A17.1-1986 elevator codes. They are:

Rule 106.1a A pit is required for all elevators.

Rule 107.1a There is to be not less than (2) two feet between the pit floor and the lowest structural or mechanical part when the car is on its fully compressed buffer.

Mr. George Diry
16 September 1986
Page 2

- Rule 107.1c The bottom car runby is to be not less than six (6) inches.
- Rule 107.1f The top car clearance is to be not less than thirty (30) inches.
- Rule 110.1 All landing openings provided with entrances which guard the full height and width of openings.
- Rule 110.2 Entrances must be horizontal slide, swing type, vertical slide or a combination horizontal slide and swing.
- Rule 110.3 (Pertains to the closing of hoistway doors.)
- Rule 203.9 A twenty-one (21) inch minimum depth platform guard is required.

Some other violations are incurred, but they are mostly incidental to the above mentioned rules.

If you require any additional information, please feel free to contact me or the Marketing Manager, Mr. Kenneth Schoenlein.

Sincerely,

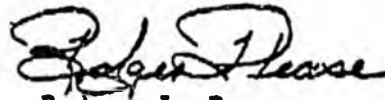
Rodger L. Pease
Applications Engineer

RLP:cs



AMERICAN ELEVATOR

1258 First Avenue South • Seattle, Washington 98134 • (206) 623-2400 / Anacortes • (206) 293-0518

August 15, 1986

Mr. George Diry
Alaska State Ferry System
P.O. Box 116
Douglas, AK 99824

Re: Shipboard elevators

Dear Mr. Diry:

Thank you for your recent inquiry regarding our elevating equipment for your State Ferry System.

To recap our conversation briefly, we discussed a cantilevered designed carframe, with an car enclosure suitable for freight and/or attendant operation.

I feel confident that we could meet your specifications in regard to elevator equipment and installation. However, I understand that the proposed system is to operate for some portion of its travel without the benefit of a shaft enclosure, which we must advise you is required by code.

I have enclosed copies of the more salient sections from ANSI A17.1 Elevator and Escalator National Code for ready reference to the rules we must abide.

We would welcome the opportunity to review your plans and specifications for elevators and pledge our assistance in selecting the best equipment for your vessels.

Yours truly,

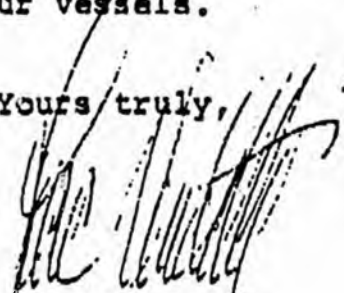
Marc Vendetti, President
American Elevator Company

V/kl
enc.

MEMORANDUM

State of Alaska
Department of Transportation & Public Facilities

TO: George Diry
Naval Architect
Marine Facilities Engineering
Alaska Marine Highway System

DATE: August 7, 1986

FILE NO:

TELEPHONE NO: 465-2734

FROM: John McGrath 
Senior Construction Manager
Marine Facilities Engineering
Alaska Marine Highway System

SUBJECT: Vessel Access
(M/V LeCONTE
Elevator)
LC/30352021

Regarding your report (draft) subject project with options a) - f), and subsequent addendum addressing option g); it was concluded in our meeting August 6 that option g) will provide the most useful lift; we shall proceed with development of option g).

As the next event prepare a package of information upon which potential suppliers of elevator equipment can advise us of the mechanical possibilities. The information should include enlarged plan and elevations of affected areas; performance requirements of the lift mechanism; special features, or limitations; and the industry, and agency requirements to which the elevator will be both built, and installed to.

We shall review this information together August 18 by which time I presume you will have made some preliminary contacts with potential suppliers.

JM/mh

cc: Joe Camp - Deputy Commissioner, AMHS, with addendum report
Harold Moeser - Director, Marine Facilities Engineering,
AMHS
Tom Shanley - Asst. Port Steward, Marine Operations, AMHS

M/V LECONTE elevator - addendum to mid-July review

- g) An "inside" landing location to be further investigated is one within the men's restroom.

The floor plan changes can incorporate the required modifications to the restrooms for both genders which are to provide "handicapped" toilet space.

A sketch of the space with minimum area for a wheelchair and attendant's lift, properly located to give access to the foyer area, is shown on sketch 11. It provides net platform dimensions of 36' x 62' and approximately 8' of space along the inboard machinery casing wall to contain the guide track(s), the driving machinery and the vertical portion of the cantilevered structure to support the "personnel caged platform." A complete "A" grade enclosure is required from the upper deck to the sun (boat) deck, including a self closing door of appropriate rating. The entire platform and its components must be made of steel.

To alleviate the overhead clearance requirements which are existing for the standard winding drum approach, and likely cannot be met, we suggested to the lift manufacturer to look at a chain drive of the type used on fork lifts. The intent being to contain the whole drive and support structure within a vertical space approximately 3 feet long and with a maximum protrusion from the supporting wall of 8 in., this excludes the horizontal cantilevered portion of the structure which is to be incorporated in the platform floor. But the manufacturer prefers to stay with the rack and pinion drive with which they have some experience.

The speculative factors due to custom manufacture and covered in 2(a) still exist, they cannot be positively answered before a certain period of time which may be critical to the realization of the program within the intended schedule.

Proposal drawings are expected which may answer some of the relevant questions.

In practice, while no solid obstruction will exist on the main deck due to the absence of tower, it will still be directed to keep the auto lane under the platform clear for a certain length, say 10 to 12 feet, resulting in the loss of one car space.

- SEE ATTACHMENTS TO
USCG/GILSON LETTER
FOR DESCRIPTION OF 'g'

DRAFT

M/V LeCONTE Elevator

This is a brief review of the investigated options to provide vertical access from the main (car) deck to the upper (accommodations) deck. Access to the forward doors is heavily favored to parallel the original staircase, but we may also consider that 25% of the harbors served use stern loading.

1. Stairway Chairlift - represented by the "Silver glide" of the American Stairglide Corp., or the "Wecolator" of the Cheney Co.

After detailed design study and inquiries with the representatives it is established that the foreign-built hardware cannot be adapted and warranted to bridge the 68 inch gap existing on the starboard face of the staircase at the first landing level.

The port facing is irregular, with many ducts and cableways and the sharp "male" corner cannot be negotiated with this system.

2. Elevators, Locations and Schemes:

- a) With access to foyer:

Requires a location @ frames 47 to 51, which condemns a large locker on the main deck.

A permanent elevator casing on the inboard side (port) of the access and machinery casing would contribute an obstruction and hazard to this parking lane. The space penalty would be at least 3 to 4 vehicles, almost 7% to 10% of capacity.

The cantilevered open type platform at this location would limit main deck interference but preliminary inquiry suggest a lengthy period before ascertaining the possibility. Regulatory compliance is also in question. The prospective supplier does not have a "standard" accepted drive system for this purpose. The rack and pinion type which would be the most compact have not up to date been used by the general public. The manufacturer also contemplated the ball screw approach which we feel may bring further functional complications in a cantilevered scheme. Their most standard winding drum approach has the drive machinery at the bottom, which in this case would set it below deck.

The required machinery and/or cantilevered frame space, below deck, demands precise compartment investigation. The location is at the forward top end of the engine room. The likelihood of many interferences may

24

YRS

YRS

(VII)
CONF.
10-1

preclude installation in this area altogether.

Those factors make it speculative to pursue this solution. 1/27

- b) The cantilevered open type option can also be contemplated between frames 40 and 42 $\frac{1}{2}$, with the inner platform edge 17 feet off centerline on the port side. The landing on the upper LVL would be in lieu of the existing life preserver storage under an access ladder. A slight after move of the ladder and inching outboard still make for a squeeze landing. W.I.
JUTE
LES
DISP

The remarks made for case (a) apply here, with the exception that the below deck space, a void partly over the sponson framing, shall not present any significant obstacle. A truss core or honeycomb type panel hinged on the side would cover the frame cavity when the lift is not in use and stored at the upper landing. W.I.
JUTE
SUP
FIR

- c) After upper deck location: (sketches 8, 9, 10) The location would be between frames 97 to 102, on either port or starboard, 7'6" to 11'9" off the centerline.

At this location the elevator constitutes only a partial access interference and only for vehicles using the stern ramp. The space penalty can be nullified by judicious placement of the lift system.

The below main deck space is part of the steering compartment where interferences are amenable to treatment. Depth below deck is limited however around 7 to 8 feet. The upper deck required casing will interfere with the mooring arrangement on the side of the elevator. A new deck layout will be necessary. W.I.
JUTE
YES

Like in (b) landing at the upper deck is not within the confines of the accommodation spaces, which makes for a more readily acceptable open lift system, i.e. without solid casing between main and upper deck. Such an arrangement can, at this location, make use of standard industrial personnel lifts. W.I.
JUTE

This latter alternative would:

- permit a shallow depth of installation below deck.
- provide standard construction common to multiple units and likely more reliability than a customized installation. W.I.
JUTE
FIR
- provide the flexibility to remove all obstruction on the main deck level if ever required.
- represent the most cost effective alternative lift.

support leg (the outboard one if two are fitted) would here have to be telescopic and self retractable upward. The scheme gets sophisticated for a custom installation. Besides the difficult structural support other inconvenience are:

- Still restrictive landing, and within the accommodation spaces.
- Elimination of 3 seats in the forward observation lounge.
- Take some area in the men's restroom, which may prove penalizing when rearranging the latter.

1 (P)N4 LE
NOT AC
R NIA
JIC 2241
V. 1/2
311-5
... 111-5

Conclusion:

Location (c), which was also selected by the crew on their 1985 SMR, may be not by pure coincidence, appears to offer the best overall compromise. The access drawback when loading from the front door can be made acceptable.

Due to the size of the vessel and the simple two levels services contemplated this writer would seriously consider adaptation of a standard industrial personnel lift of the scissor type with electro-hydraulic power.

GD/mh

048 -- DIRY2