

**1/26/10
LUNCH &
LEARN:
WOOD
RESIDUE
GREEN
ENERGY**

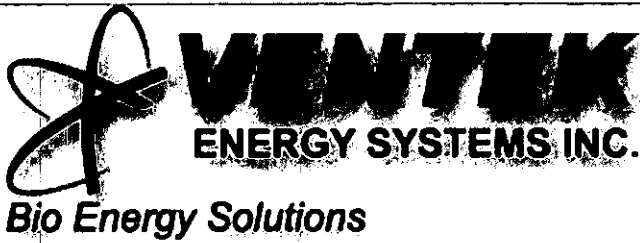

Wood Residue Green Energy

For SE Alaska

VENTEK/SEALASKA

Peter Brand
January 26, 2010
pbrandd@me.com

Overview

- Introduction and why are we here....
- Biomass overview
- Trends in Europe and N America
- Northern Examples – Yukon, NWT, and BC
- Opportunities for Alaska

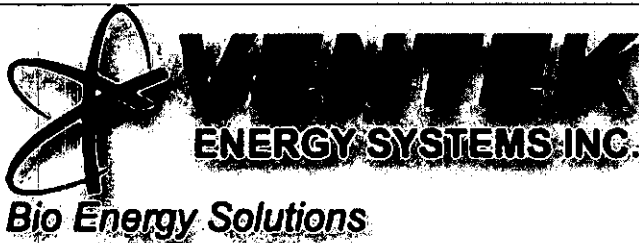

Introduction – Peter Brand

- 27 year career in the electrical business with **BC Hydro**, primarily distribution engineering, remote area and district management.
- 11 years with **Pinnacle Pellet** in Quesnel BC as Partner, Vice – President, Marketing and Business Development.
- Instrumental in growing Pinnacle’s annual sales from less than 20,000 tonnes in 1999 to over 700,000 tonnes in 2008. Increased production plants from one to five. Currently #2 in world production.
- Since retirement from Pinnacle, bioenergy consultant, with clients such as **Yukon Government, Ventek Energy, Sealaska, NWT Government, Zilkha Bioenergy (Texas) and Prairie Green Renewable Energy (Sask).**

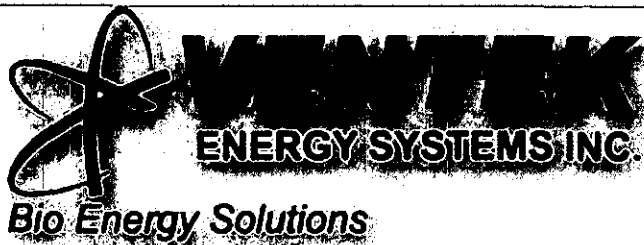

Introduction

Ventek Energy Systems

Rod Graham and Markku Riionheimo

Viessmann North America

Simon Koeb

Sealaska Corp

Rick Harris, Wade Zammit, Ron Wolfe, Nathan Soboleff

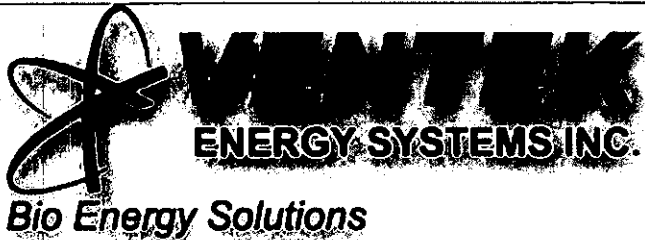

Why are we here....



"Press Release, Dec. 2009

Sealaska to Convert Plaza to Biomass Fuel

Juneau, Alaska— In 2010, Sealaska Corporation's corporate headquarters in Juneau will become the first commercial building in Alaska to convert to renewable bio-energy. Sealaska will convert its corporate headquarters to a wood pellet fired boiler system. The Sealaska Plaza is currently heated by over **35,000 gallons** of heating oil per year. Sealaska's goal is to establish a green energy model that can be applied throughout Southeast Alaska. The effort is one element of Sealaska's green initiatives to build sustainable Southeast Alaska economies. We believe this project will show that conversion to biomass can save money, reduce hydrocarbon-based footprints and create anchor demand for resources that can be manufactured within the region."

Savings will be approx. 8400 tons CO2 over 25 yrs and over \$1m in energy costs.

Sealaska Energy Initiative

- Reduce CO²
- Reduce Energy Costs
- Create local jobs in SE Alaska
- Start by setting an example with Sealaska Plaza

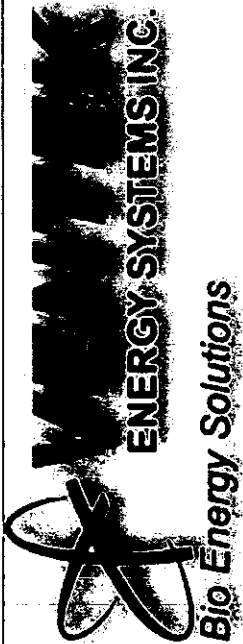

Why are we here....



Concepts of Biomass

No new CO₂
added to the
environment.

Plants absorb carbon
dioxide when they grow



The energy stored in plants
(biomass) can be used to make
electricity

Carbon dioxide released
= carbon dioxide absorbed

Replanting and new growth
ensures sustainability

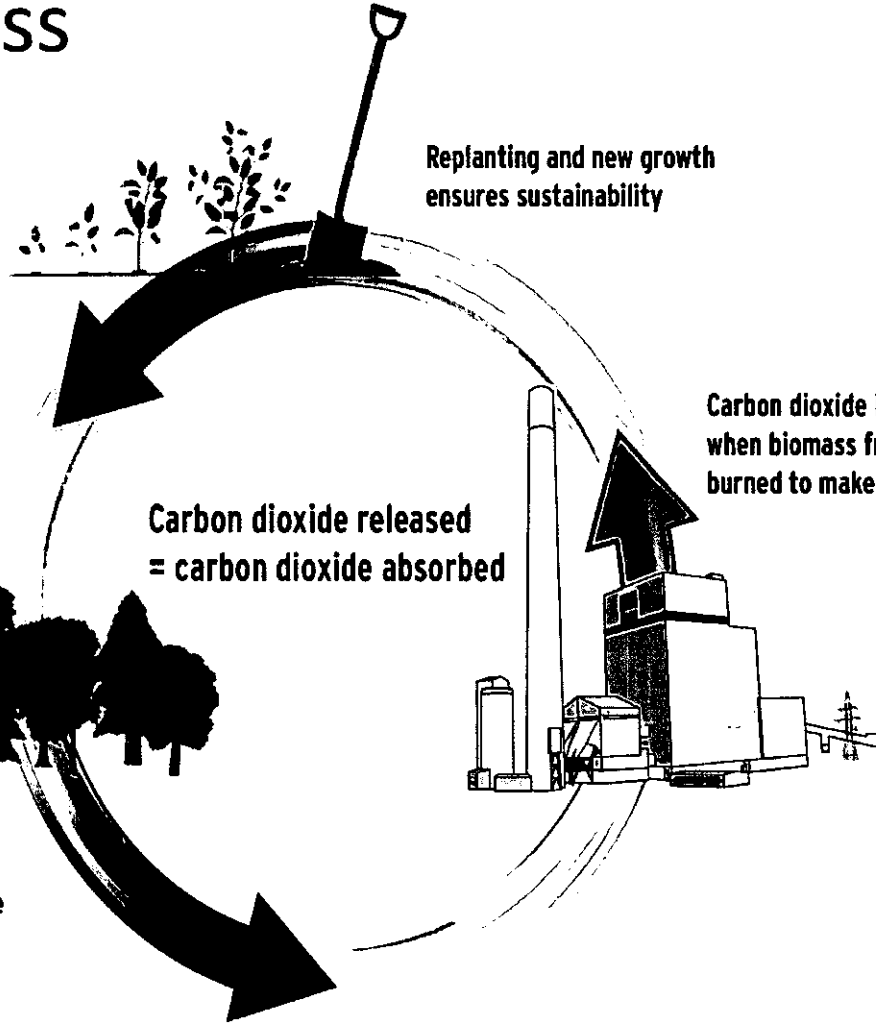

Carbon dioxide is released
when biomass from plants is
burned to make electricity

As plants grow they absorb carbon dioxide, a greenhouse gas that contributes to climate change, from the atmosphere. When they are used to make electricity the carbon dioxide stored by the biomass is released. No new net greenhouse gases are produced making biomass fuel 'carbon neutral' - better than fossil fuels which are major contributors to climate change

Concepts of Biomass

- Wood Pellets are “Carbon Neutral” and “Sustainable”
- Jobs and profits are local
- Energy savings are real, 30-50%
- Public is demanding reductions in carbon output
- Local impacts of climate change are very evident
- Europeans are much further ahead than N America

Concepts of Biomass

- Boiler technology is just recently being transferred from Europe
- Government incentives/penalties are just being launched
- There are many other proposed “green” solutions, such as:
 - Tidal, Micro (or small) Hydro
 - Wind and Solar
 - Geo Thermal
 - Ethanol
 - Other Biomass (Wood chips, olive pits, energy crops, etc.)
 - Controversial options such as nuclear and “clean” coal
 - Conservation.... Perhaps the biggest and most cost effective

Strong Clean Energy Market Fundamentals

OIL AND GAS LIQUIDS
2004 Scenario

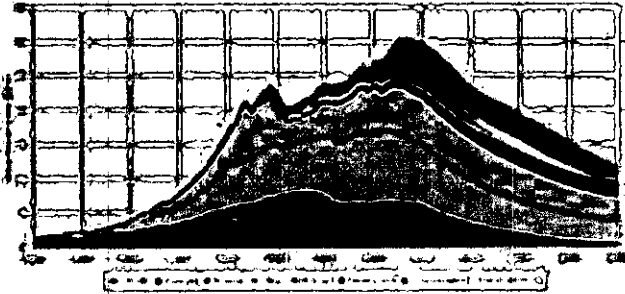

➤ **Oil & Gas peak & price**

➤ **Energy security**

➤ **Global warming & environment**

➤ **Public awareness**

➤ **Rush to benefit**

(GE sales of "green" products and services now \$12b/yr)





VENTEK
ENERGY SYSTEMS INC.

Bio Energy Solutions

Concept of "Peak Oil", Hubbert Chart



A NATIVE CORPORATION
SEALASKA

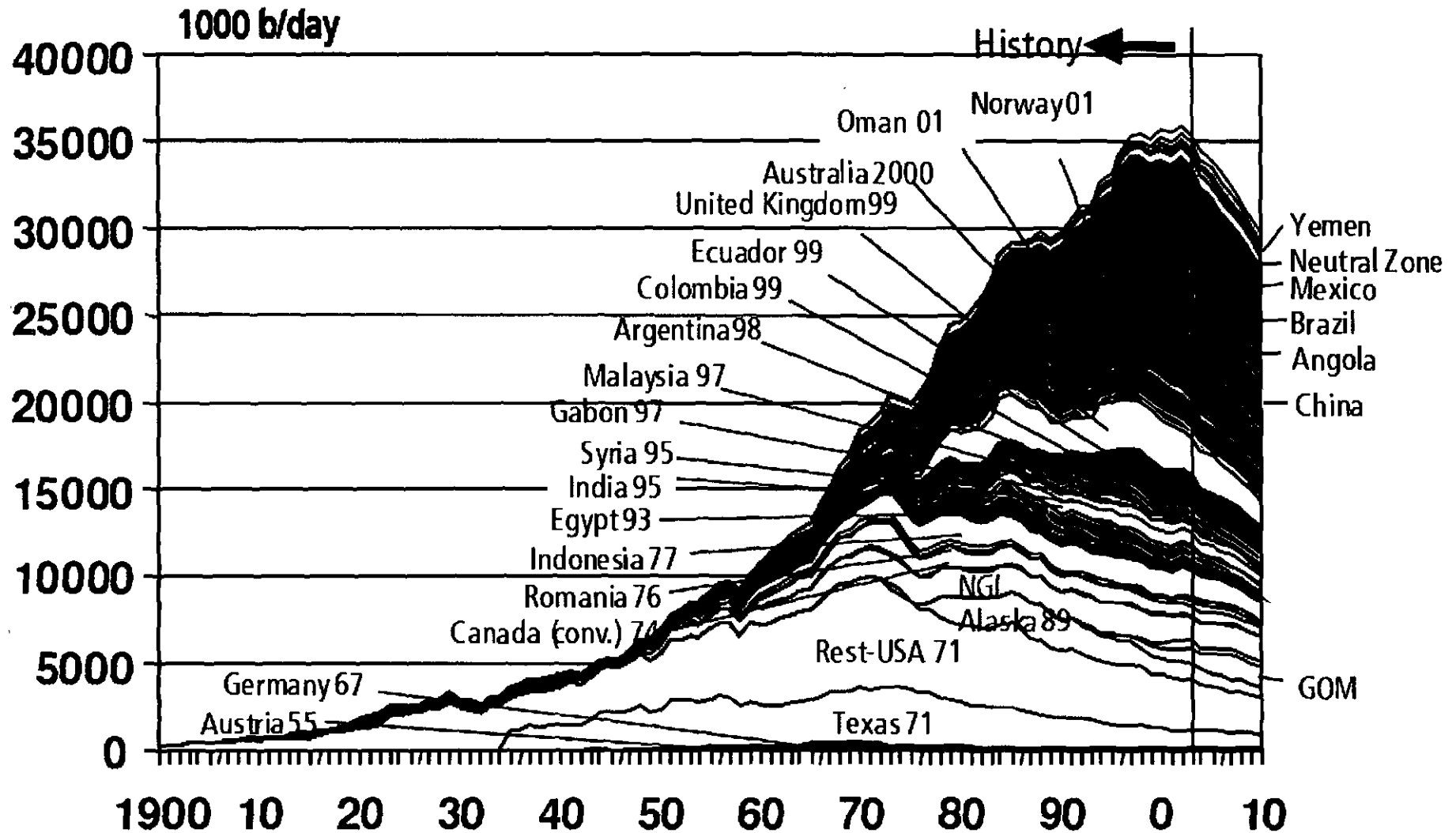

Source: Industry database, 2003 (IHS 2003)
OGJ, 9 Feb 2004 (Jan-Nov 2003)

North
American
energy plant

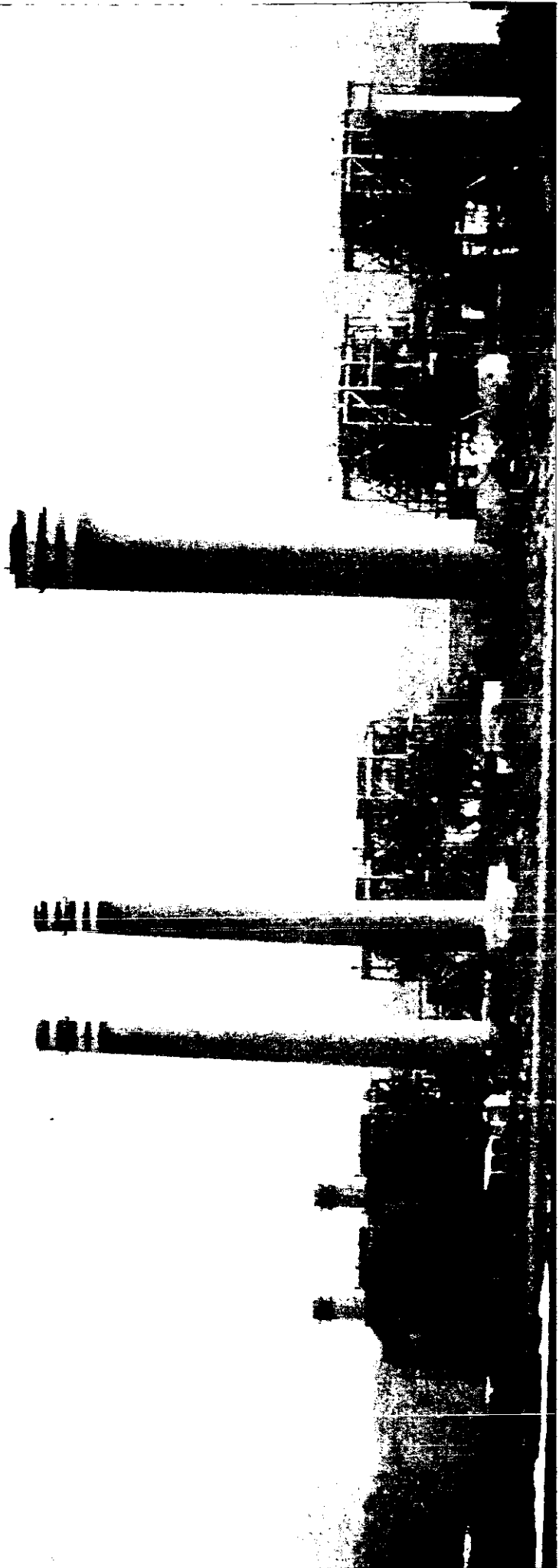

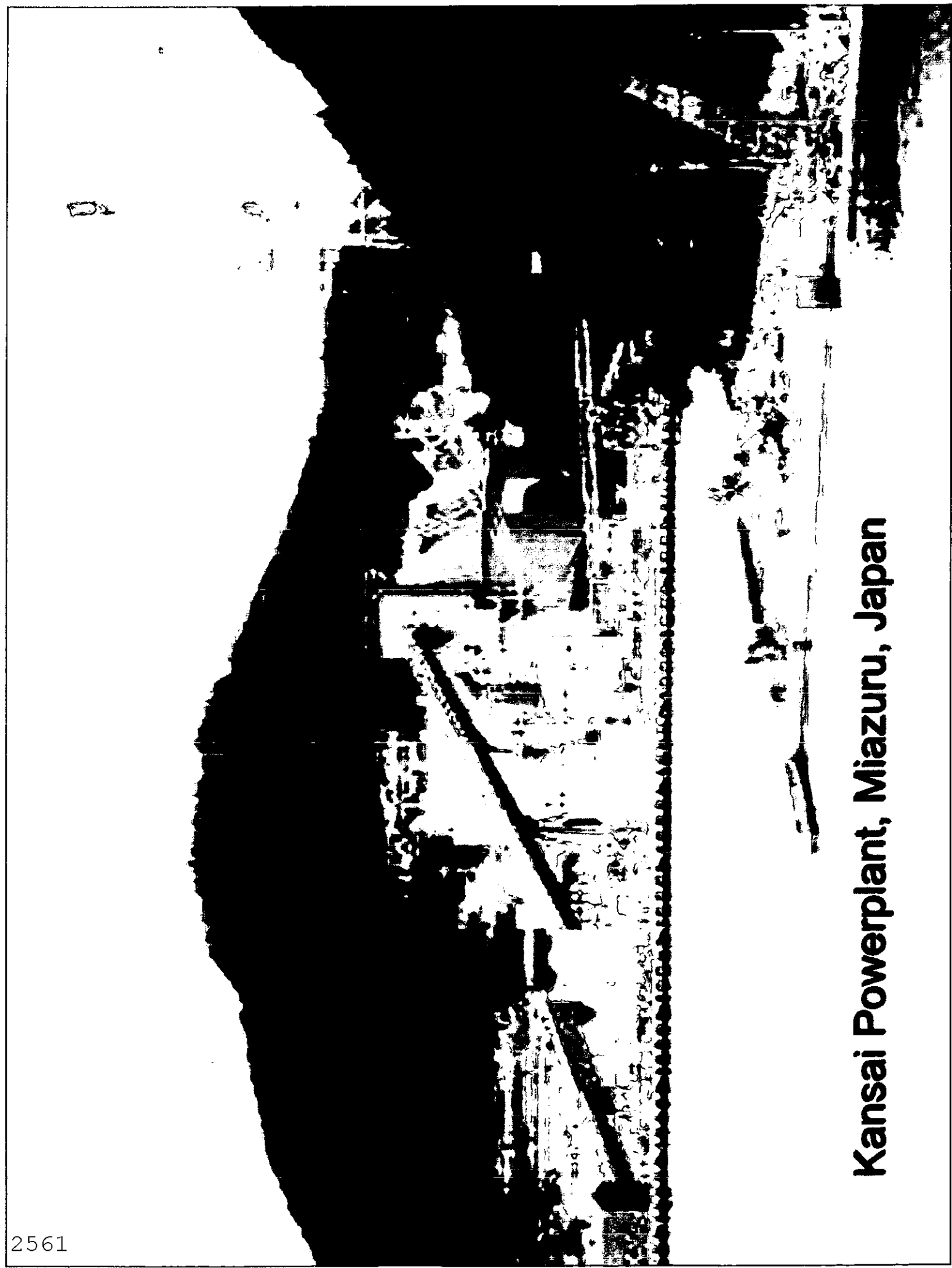

Kansai Powerplant, Miazuru, Japan

Geertruidenberg, Netherlands

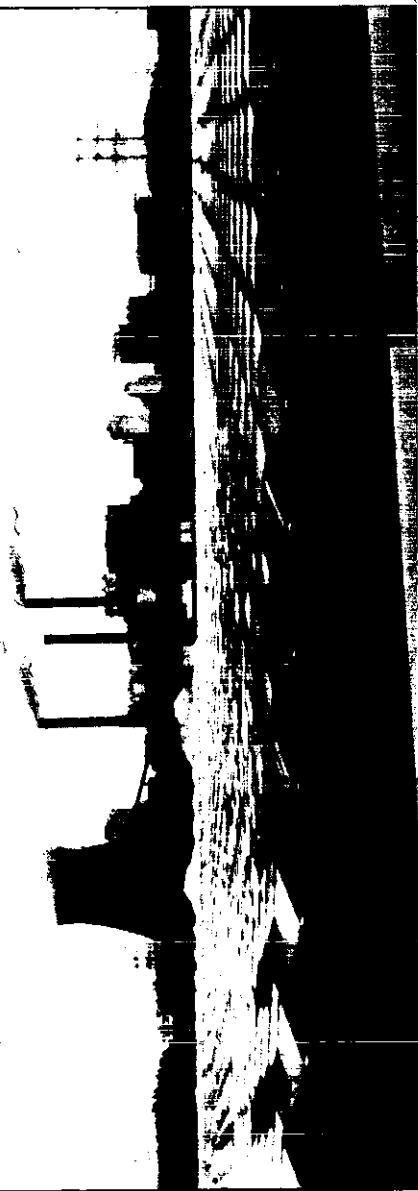

Helsingborg, Sweden

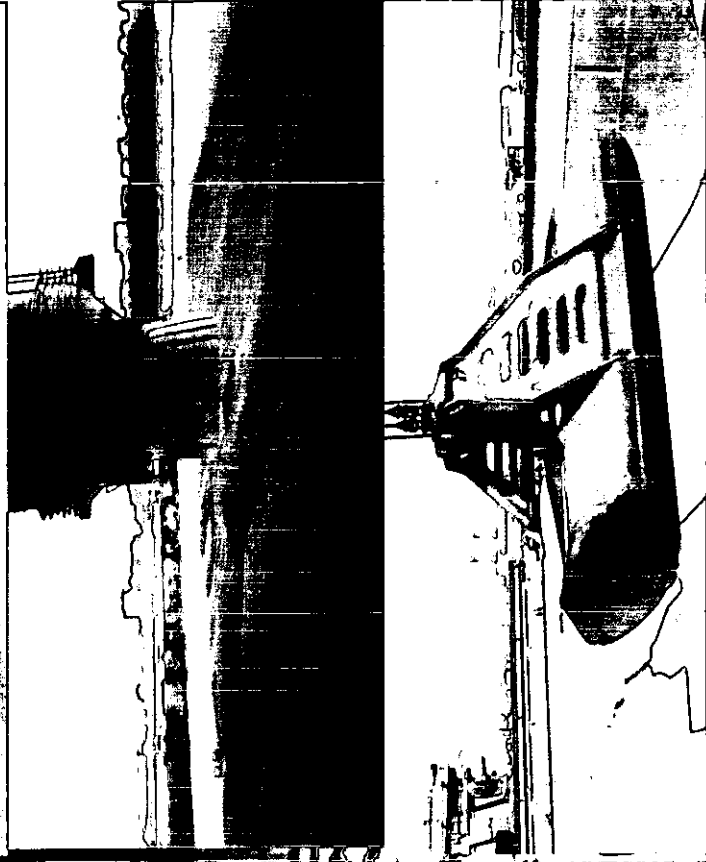
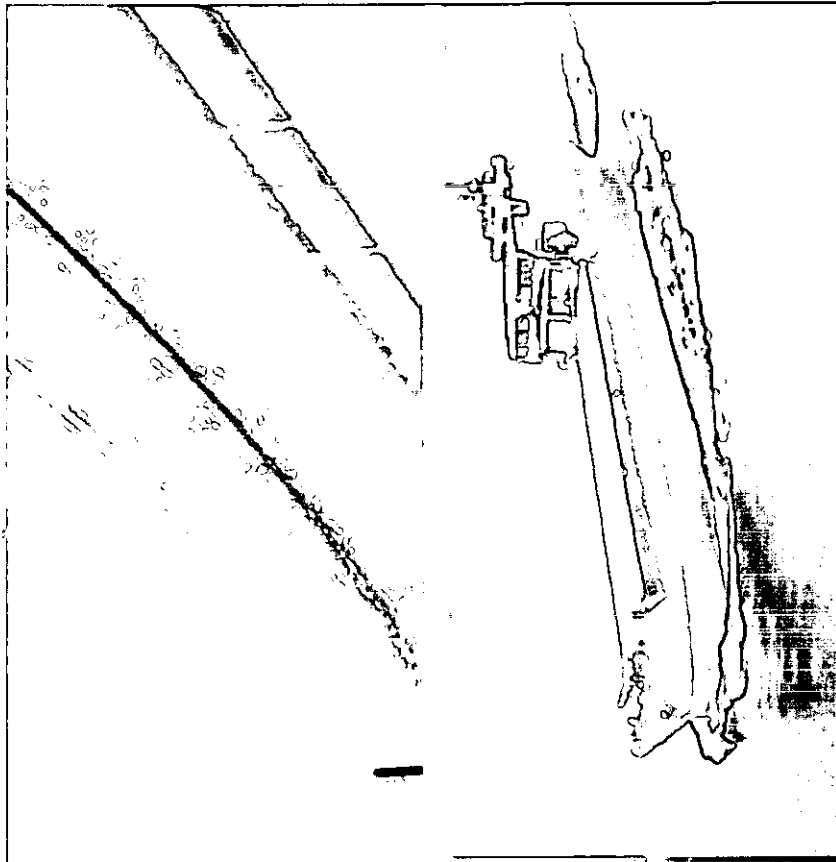
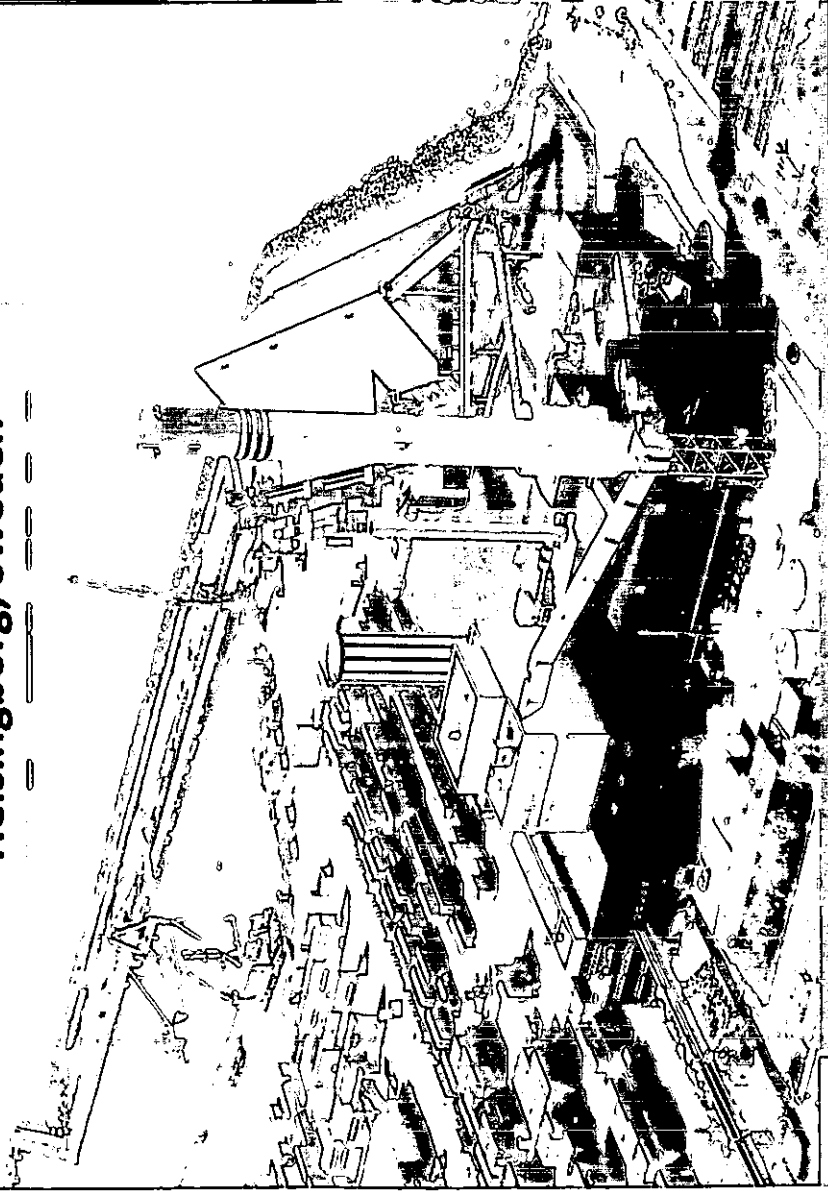



VENTEK
ENERGY SYSTEMS INC.

Bio Energy Solutions



A NATIVE CORPORATION
SEALASKA

Danish pellet market

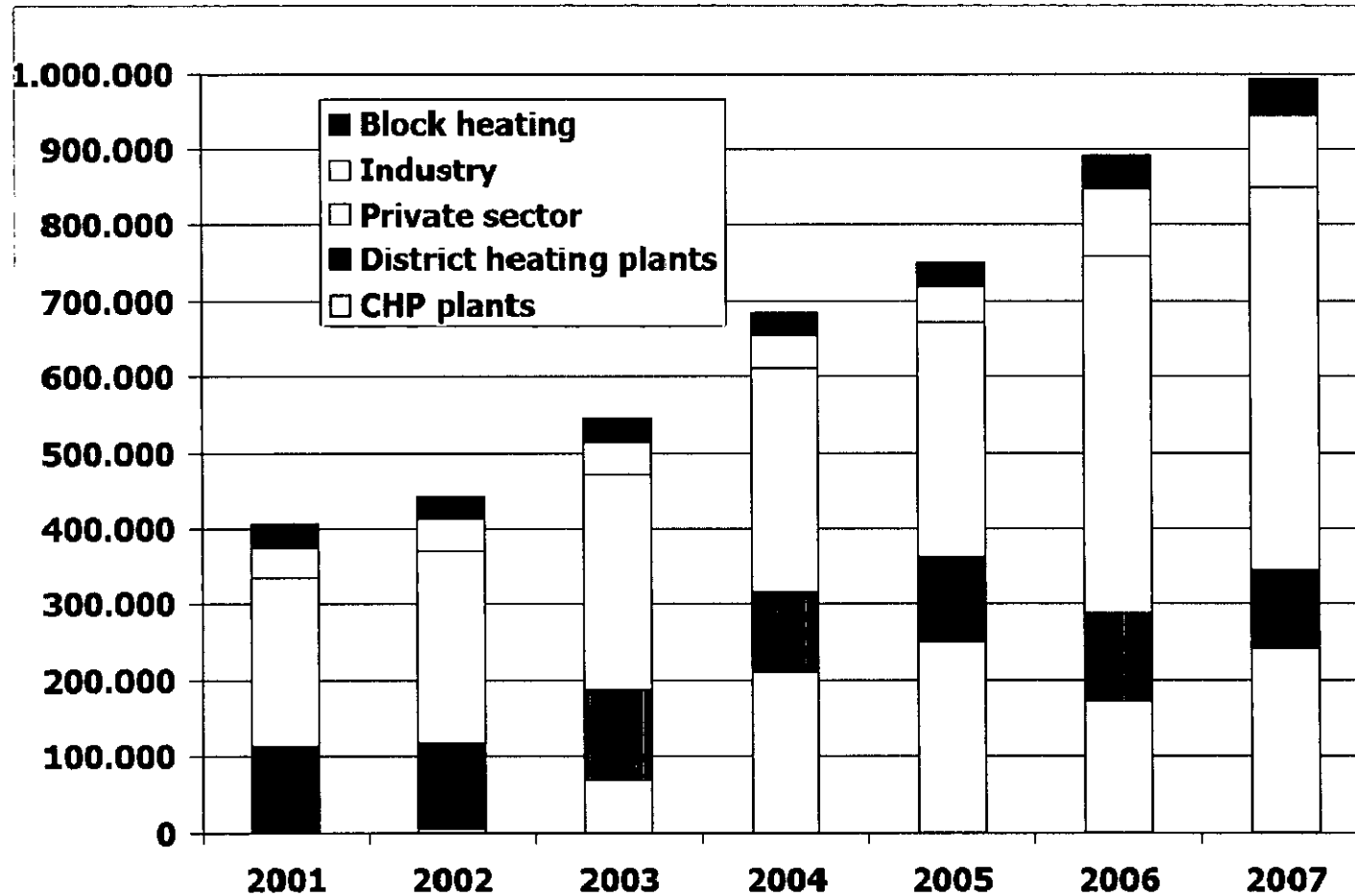

Source: Hansen, Force, Wels 2009

Future Pellet Market in Denmark

- Residential market: increase expected
- District heating market: decrease expected
- Large CHP market: large increase expected
 - DONG Energy
 - 400,000 tonnes at Avedøre II in 2009
 - Vattenfall
 - 100,000 tonnes straw pellets and 250,000 tonnes wood pellets at refurbished Amager plant
 - MaxBio plan on replacing 724,000 tonnes of coal with biomass
- Danish pellet market could double in 5 years!

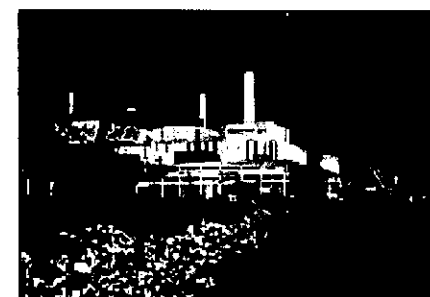

Pellet stoves in France

Cumulated sales of pellet stoves in France, ITEBE

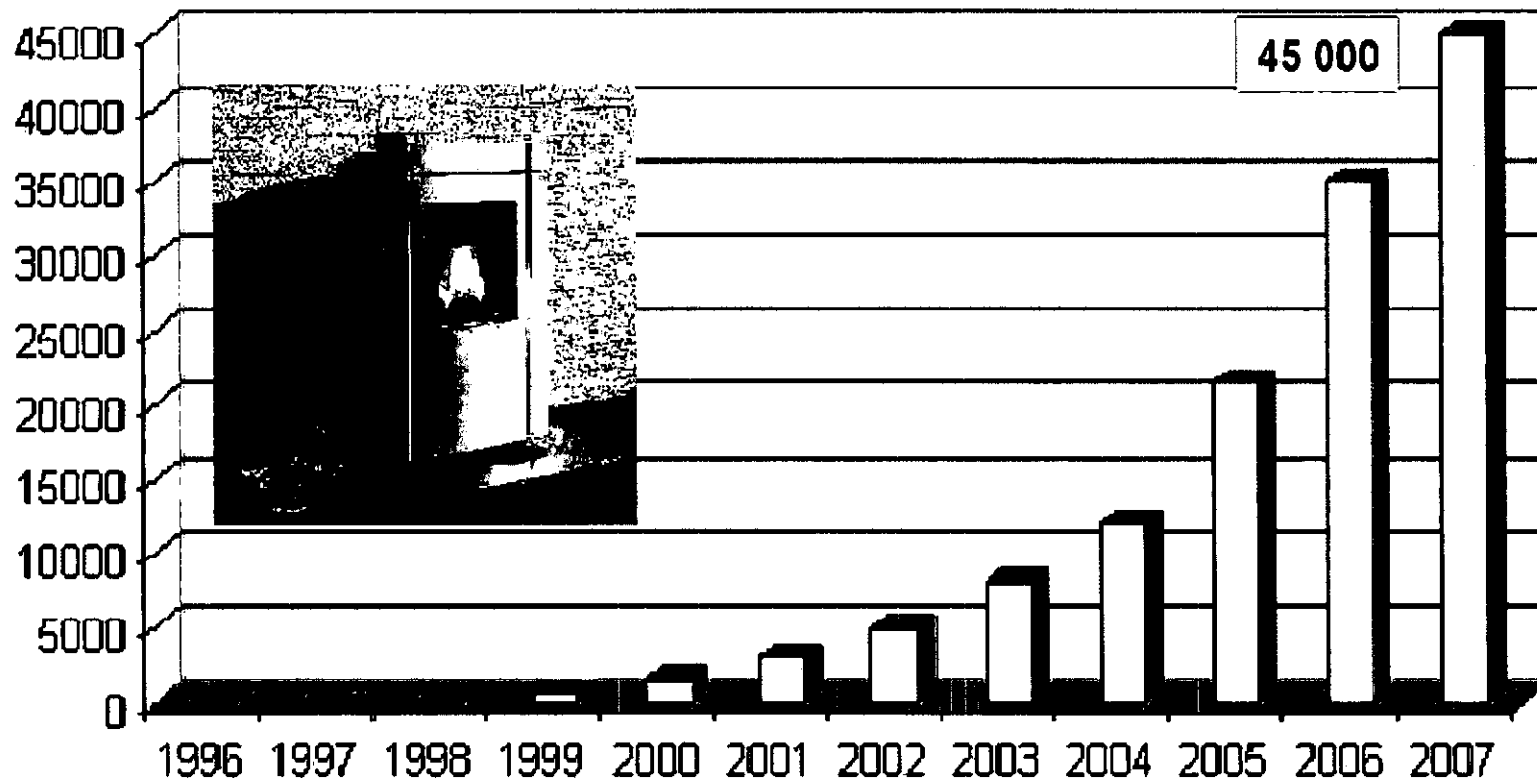

Source: ITEBE, Wels 2009

Swedish pellet market

Delivery to the Swedish market (tonnes)

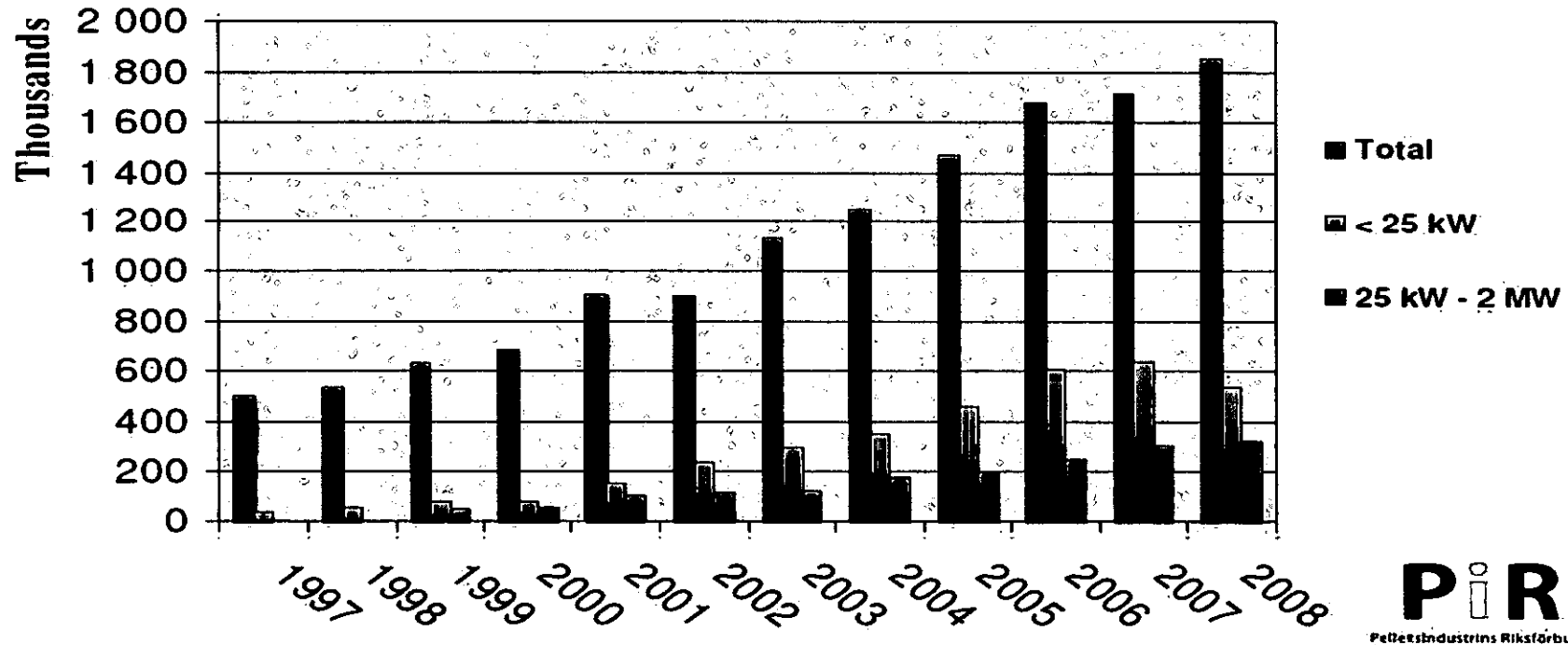

PiR
Pellletsindustrins Riksförbund

Production and import of pellets in Italy

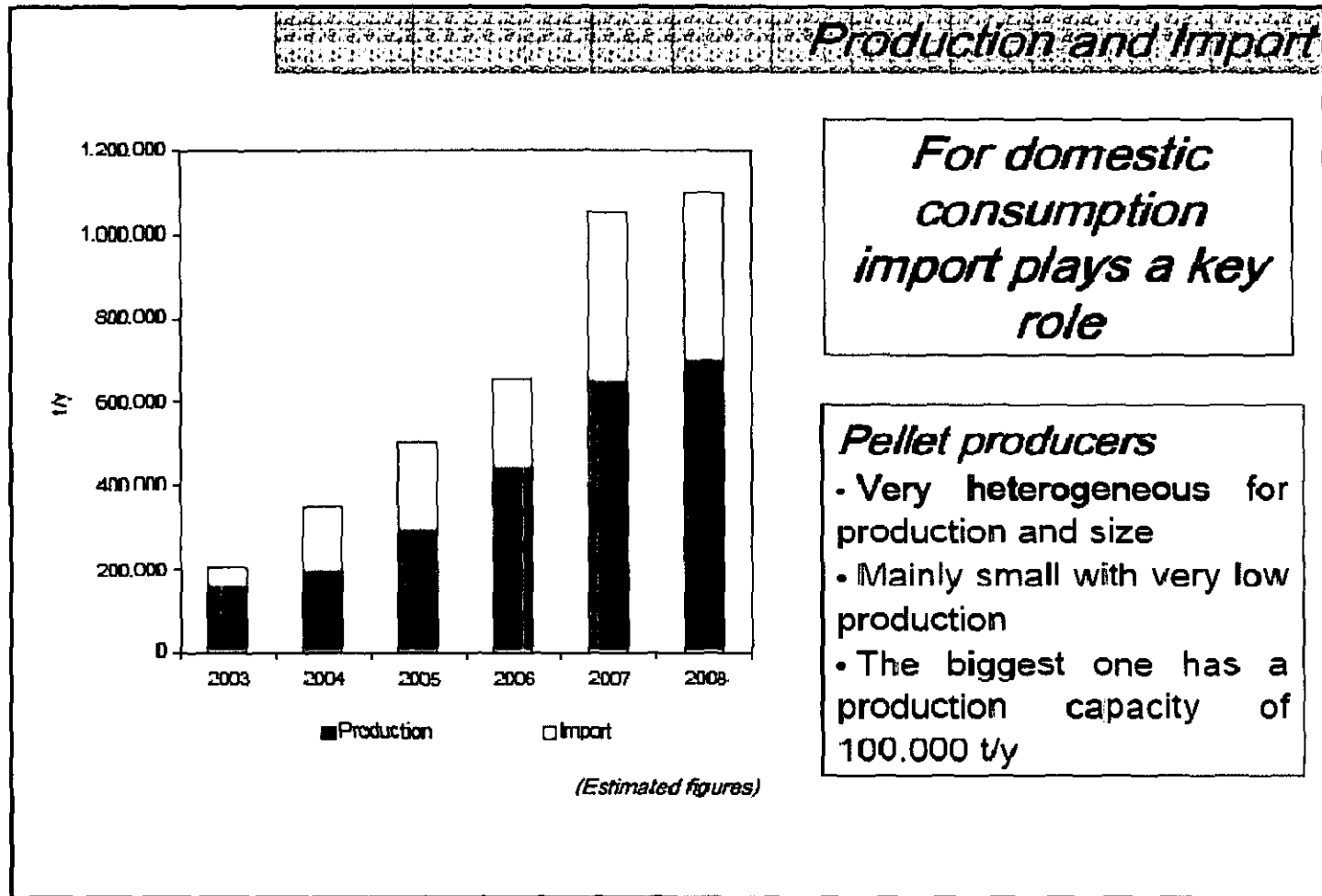

Source: Paniz, AIEL, Wels 2009

Residential pellet boilers in Germany

Pelletheizungen-in-Deutschland.gif

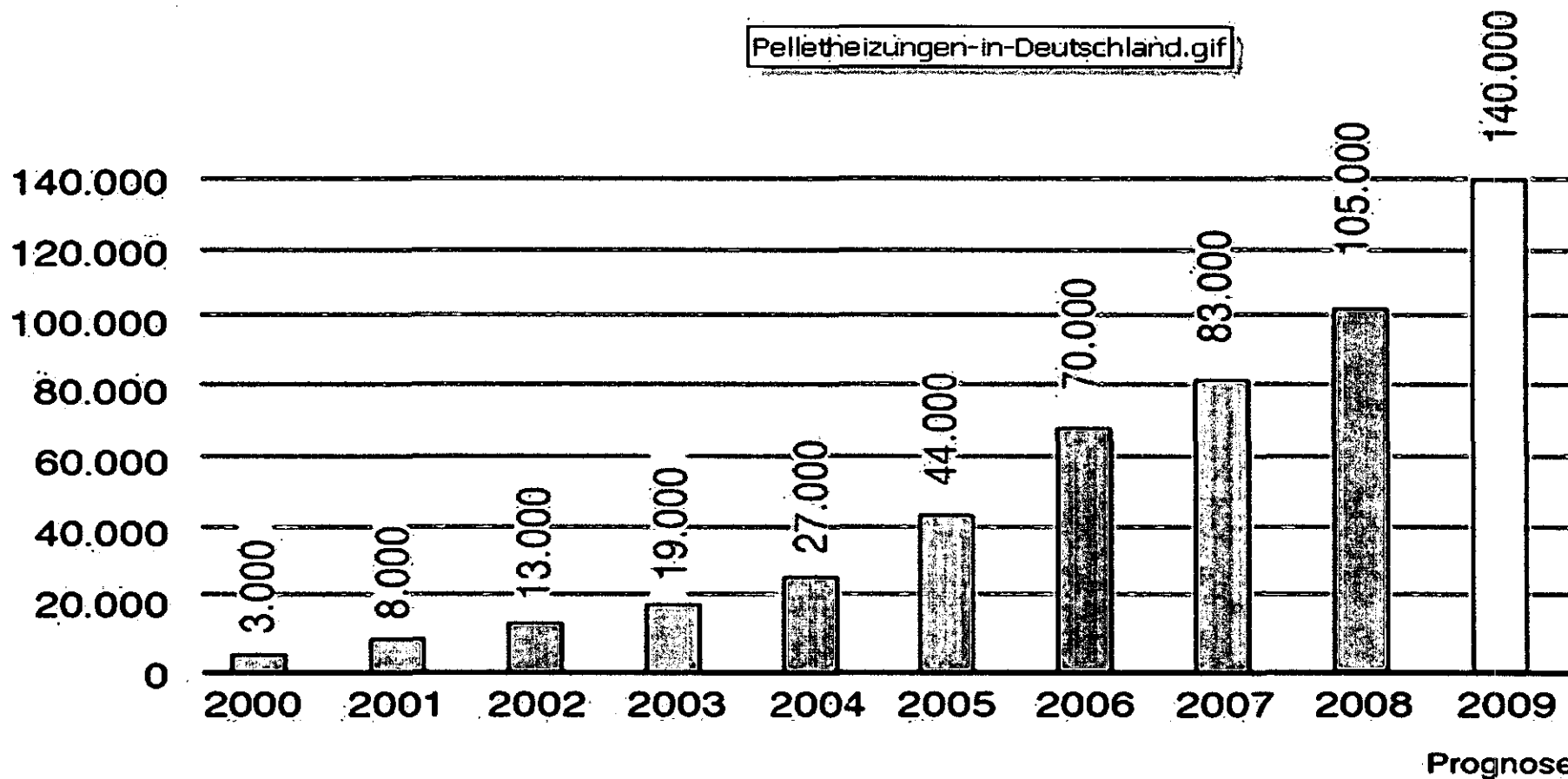

© Deutsches Pelletinstitut

Quelle: *BAFA-Zahlen, geförderte Heizkessel und wassergeführte Öfen

Source: Proske, DEPI, Wels 2009

Projected sales of pellet boilers in Spain

Total pellet
boilers
installed:
1.000 Units
54 MWt

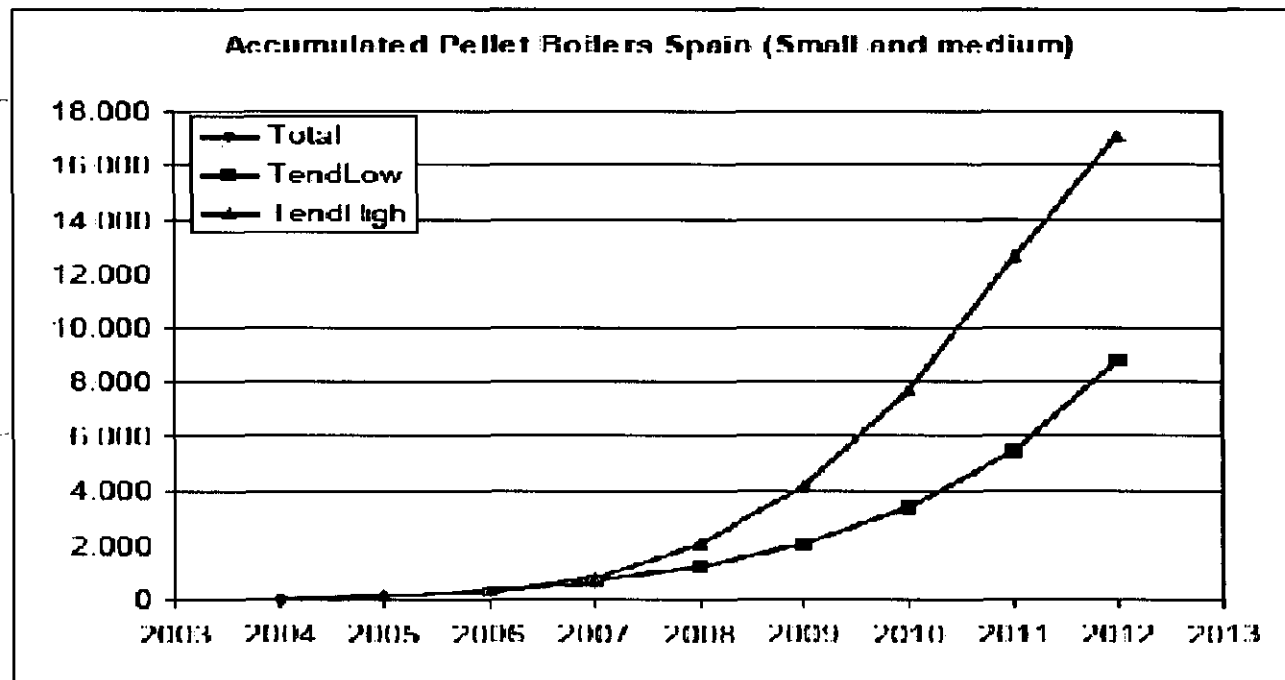

21/01/2009

www.biohousing.eu.com

11

Source: Puente-Salve, Escan, Wels 2009

Development of pellet production in the UK

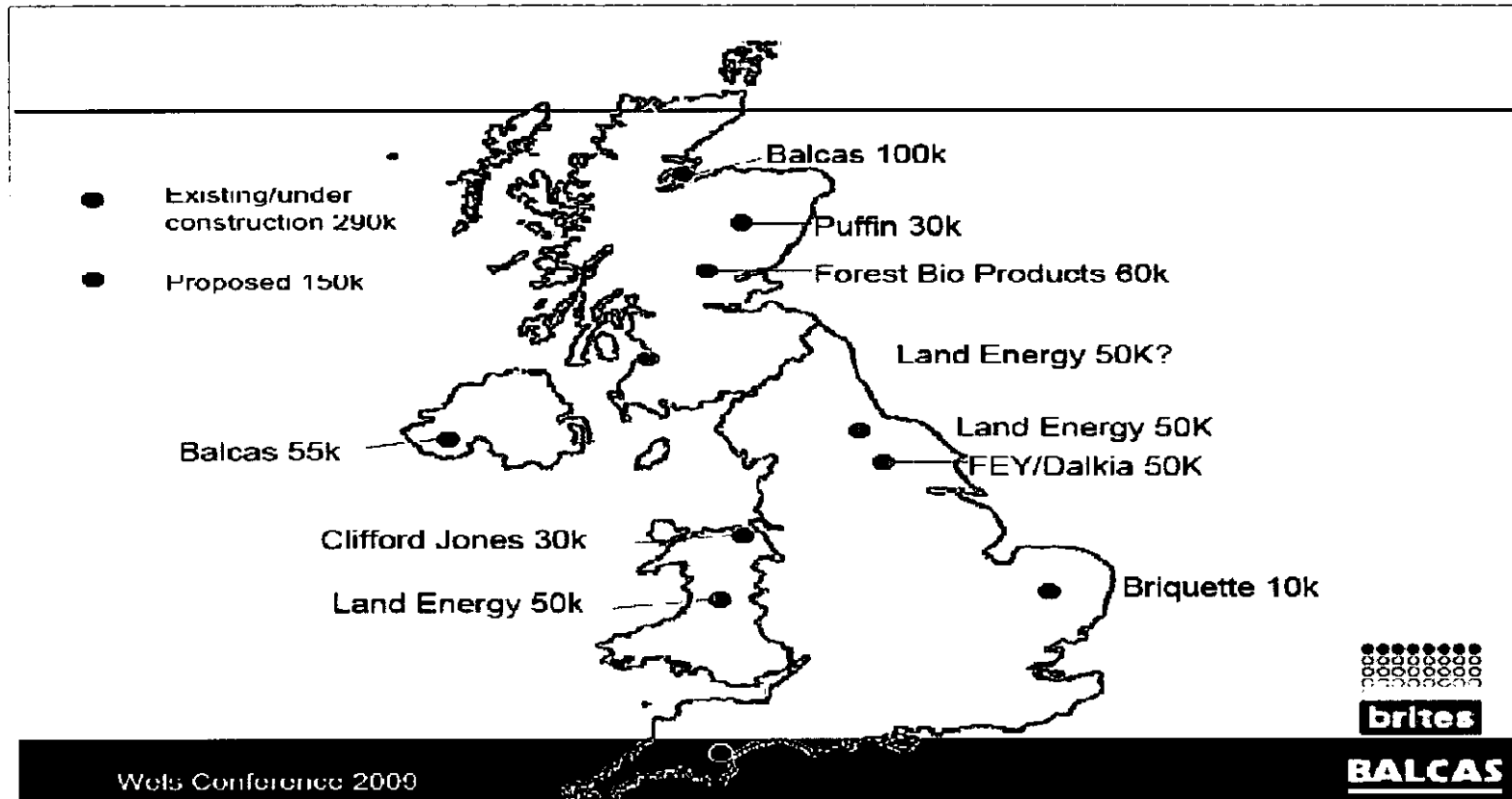

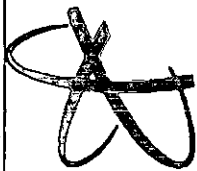

ENERGY SYSTEMS INC.

Bio Energy Solutions



A NATIVE CORPORATION

SEALASKA

Two boiler KOB system Brunstad Congress center (Norway)

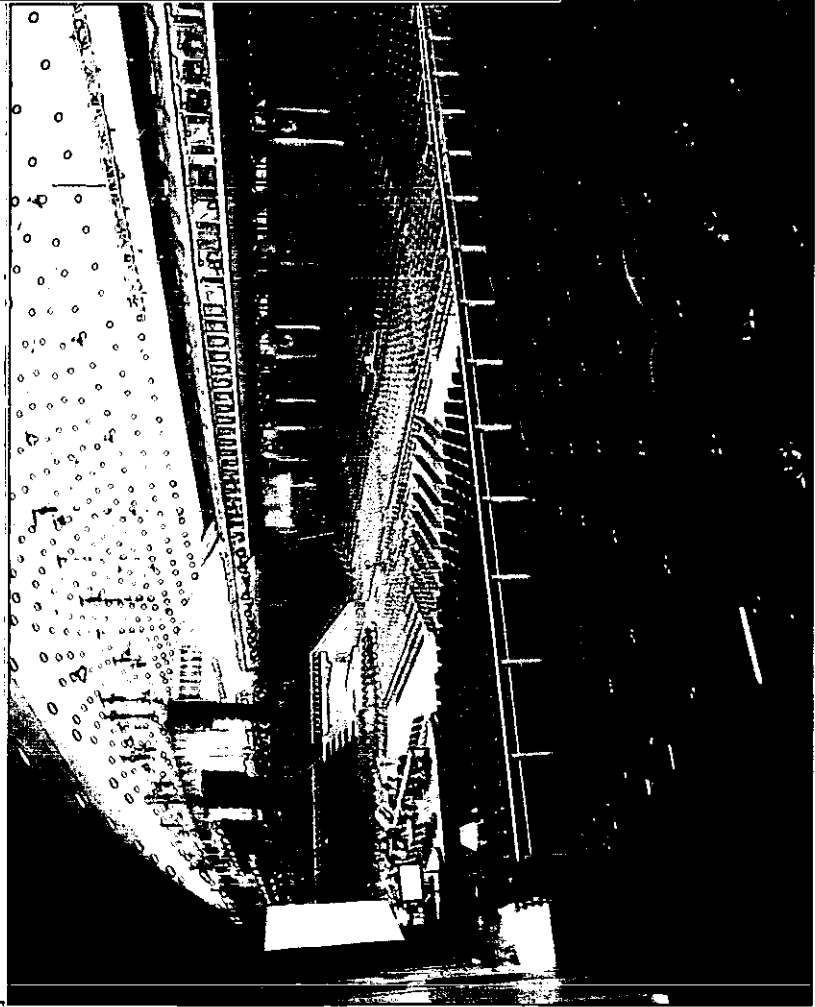

Pellet production and consumption in Poland

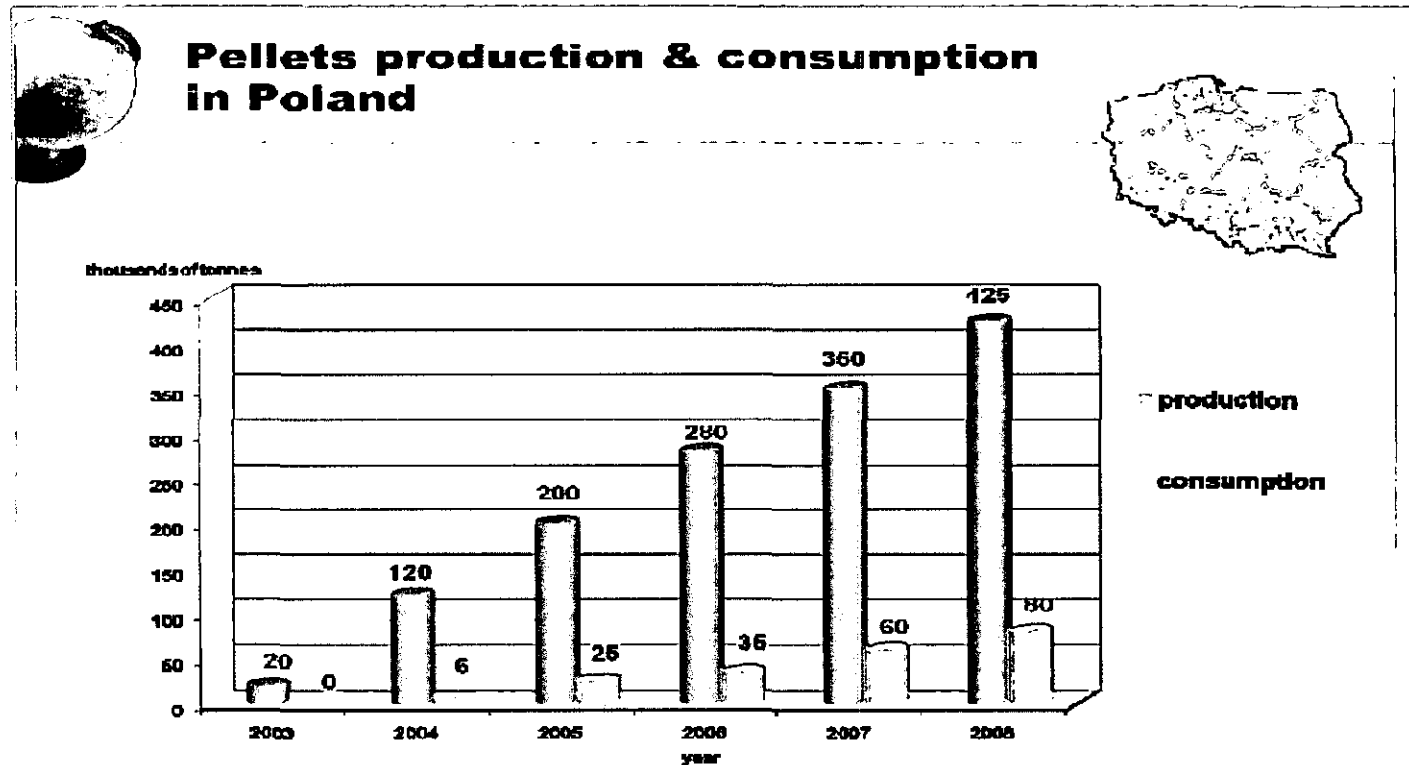

Wach, Energy and Environmental Conservation, Wels 2009

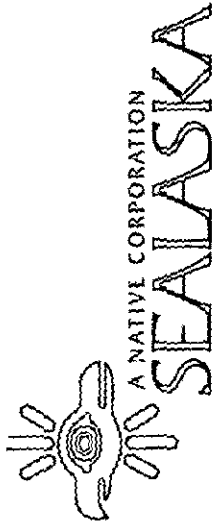
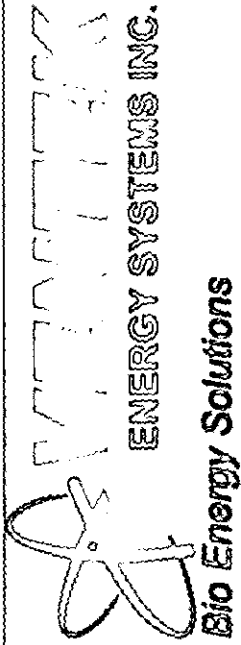

KOB heated Hotel Lagorai Cavalese (Italy)

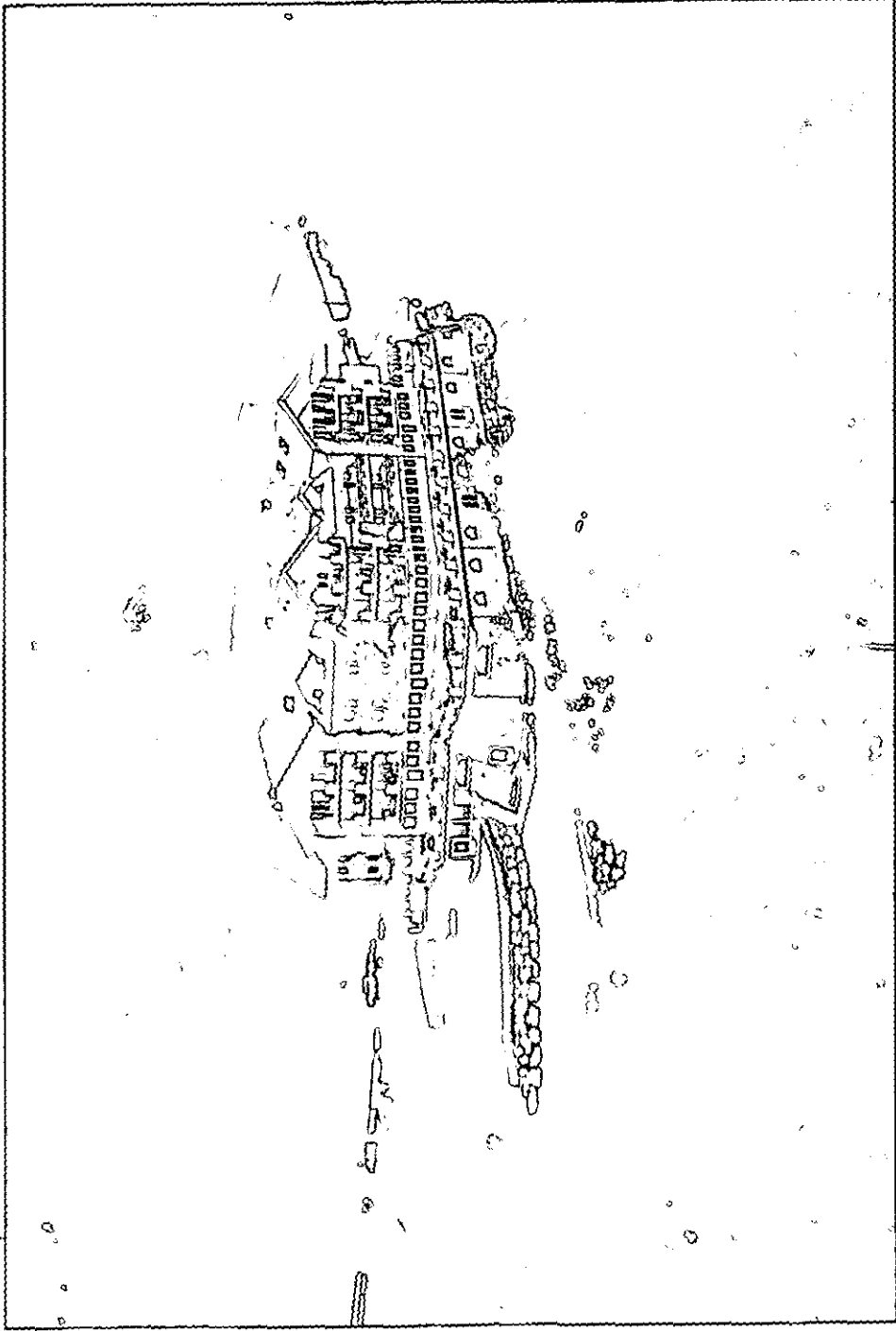

KOB heated 3 Apartment Buildings Skien, Norway

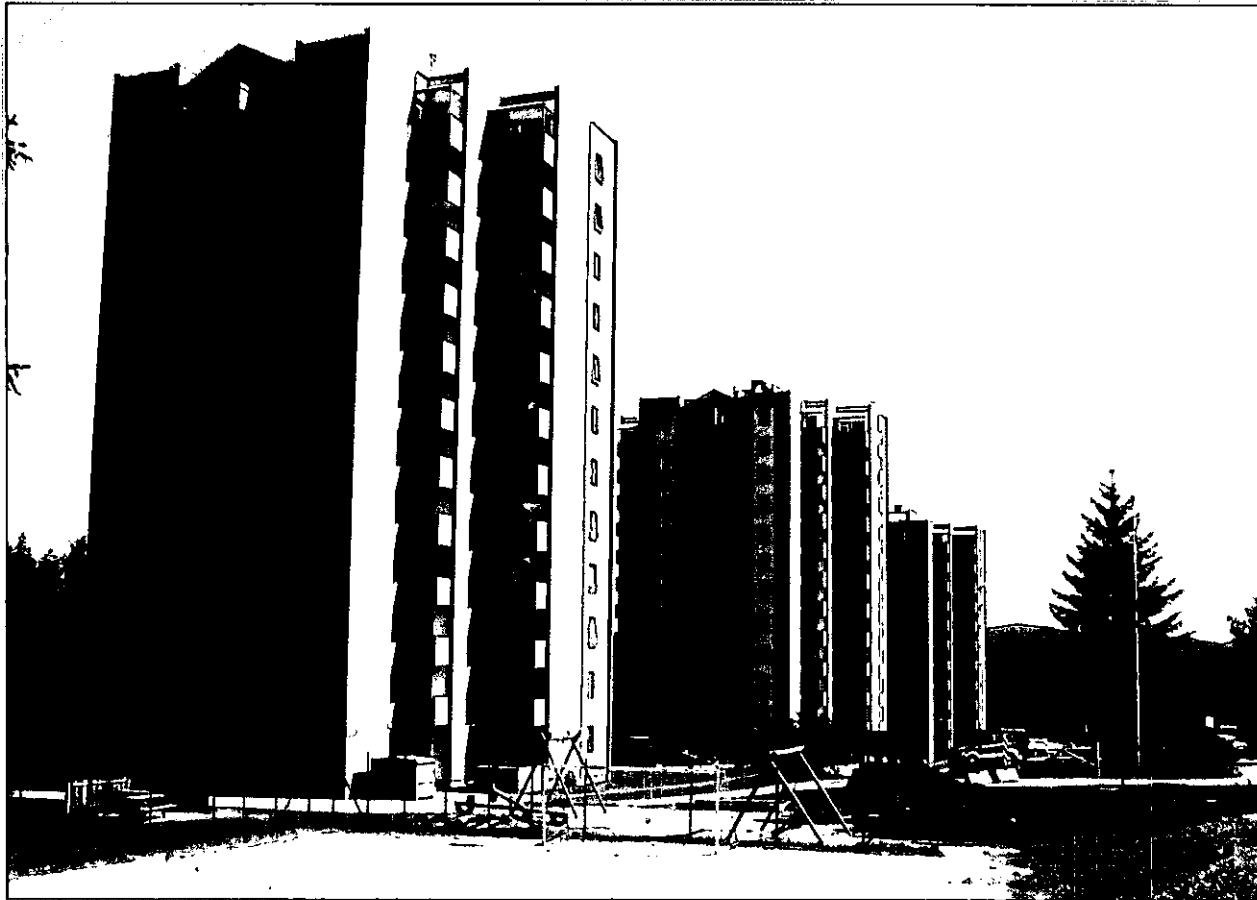

USA: Development of pellet stove sales

USA Pellet Appliance Shipments 1998-2008

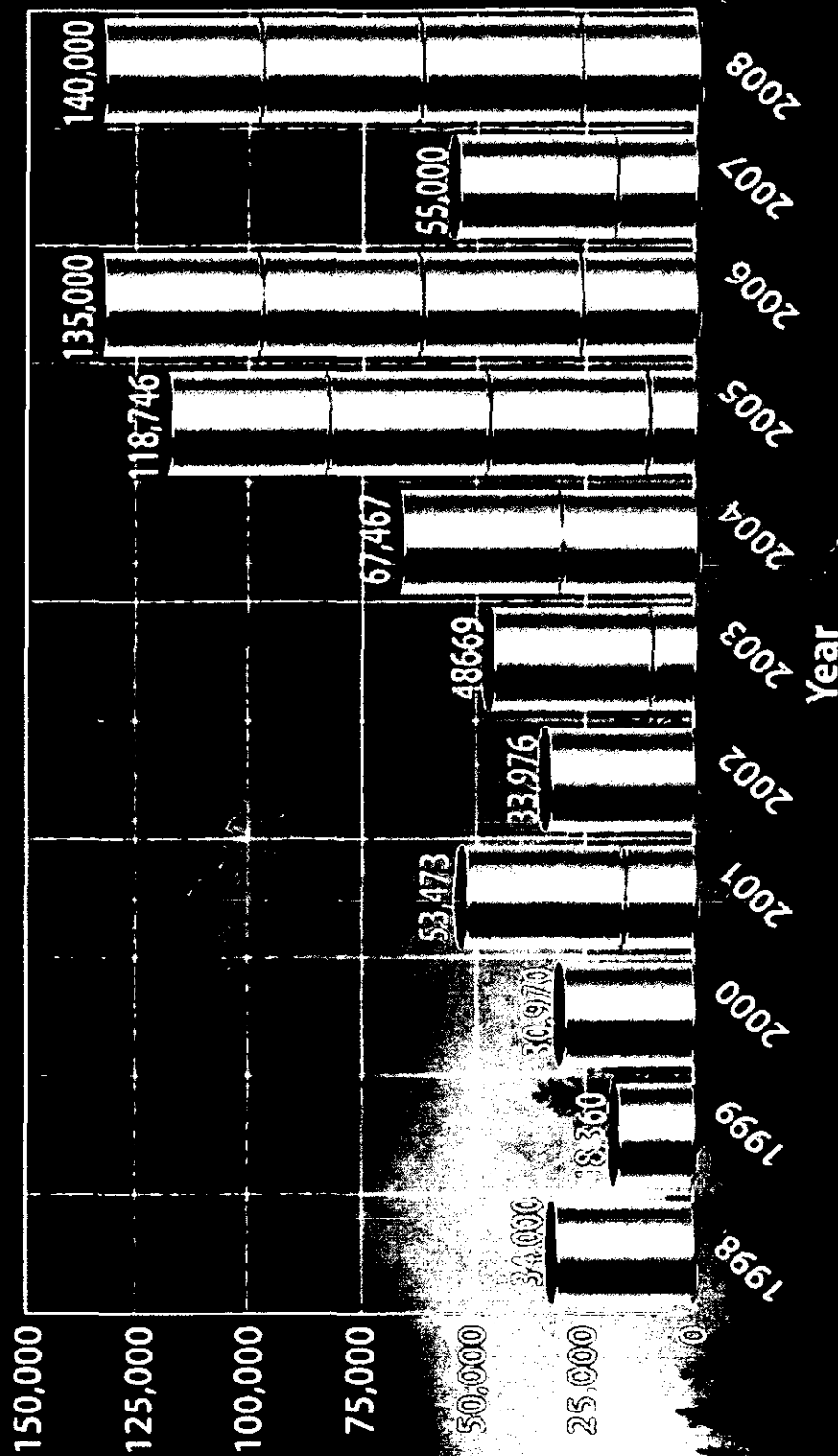

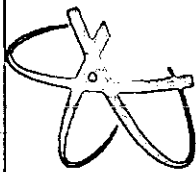

ENERGY SYSTEMS INC.

Bio Energy Solutions



A NATIVE CORPORATION
SEALASKA

USA Wood Pellet Production

USA Wood Pellet Production in tons 2002-2008

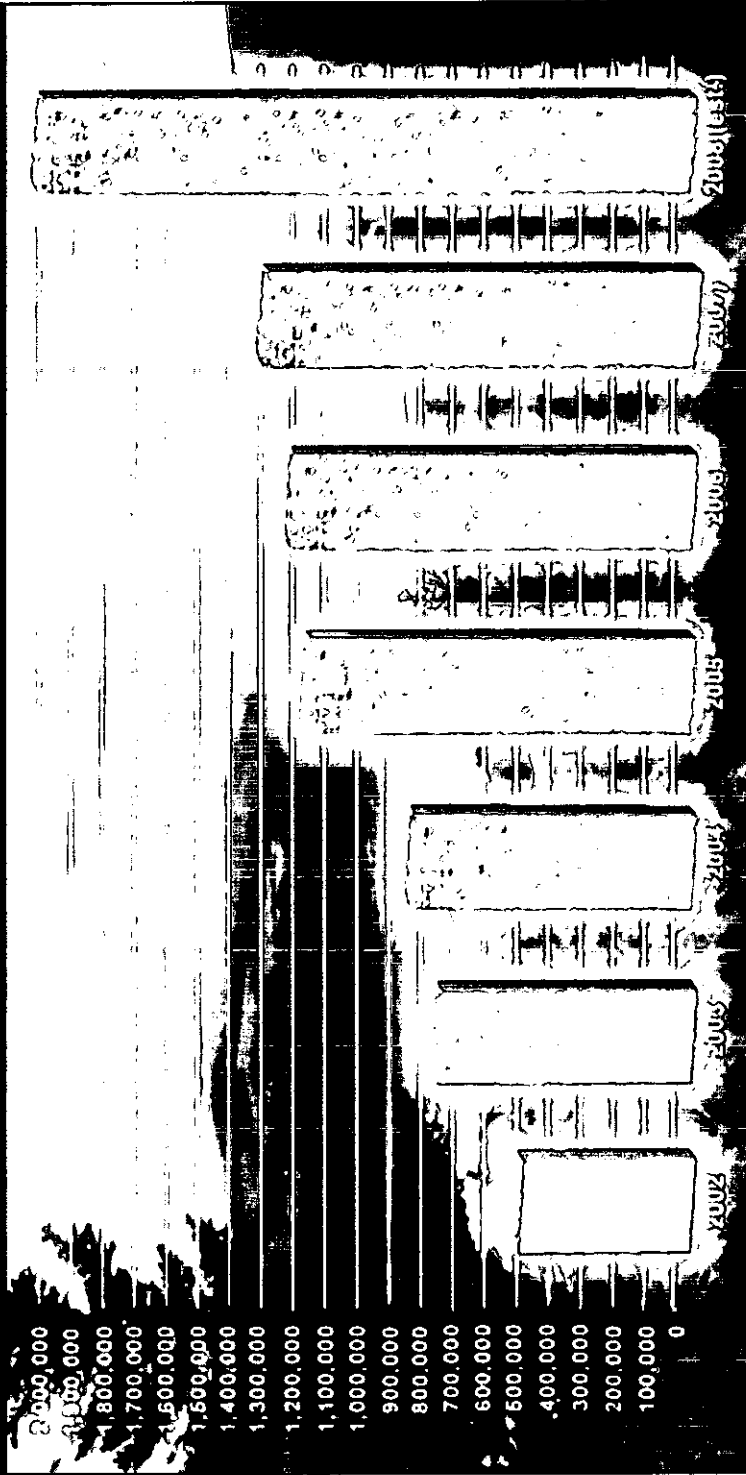

Bear Mountain Forest Products

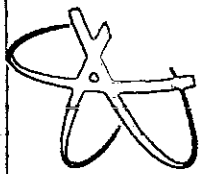

MENTEK
ENERGY SYSTEMS INC.

Bio Energy Solutions



A NATIVE CORPORATION
SEALASKA

2004 US Pellet Producers

**2004 USA Pellet Producers
21 Plants- 850,000 tons**



Bear Mountain Forest Products

Source: Stan Elliot, Wels 2009

2009 US Pellet Producers

2009 USA Pellet Producers 80 Plants- 2,000,000 tons

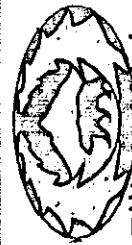
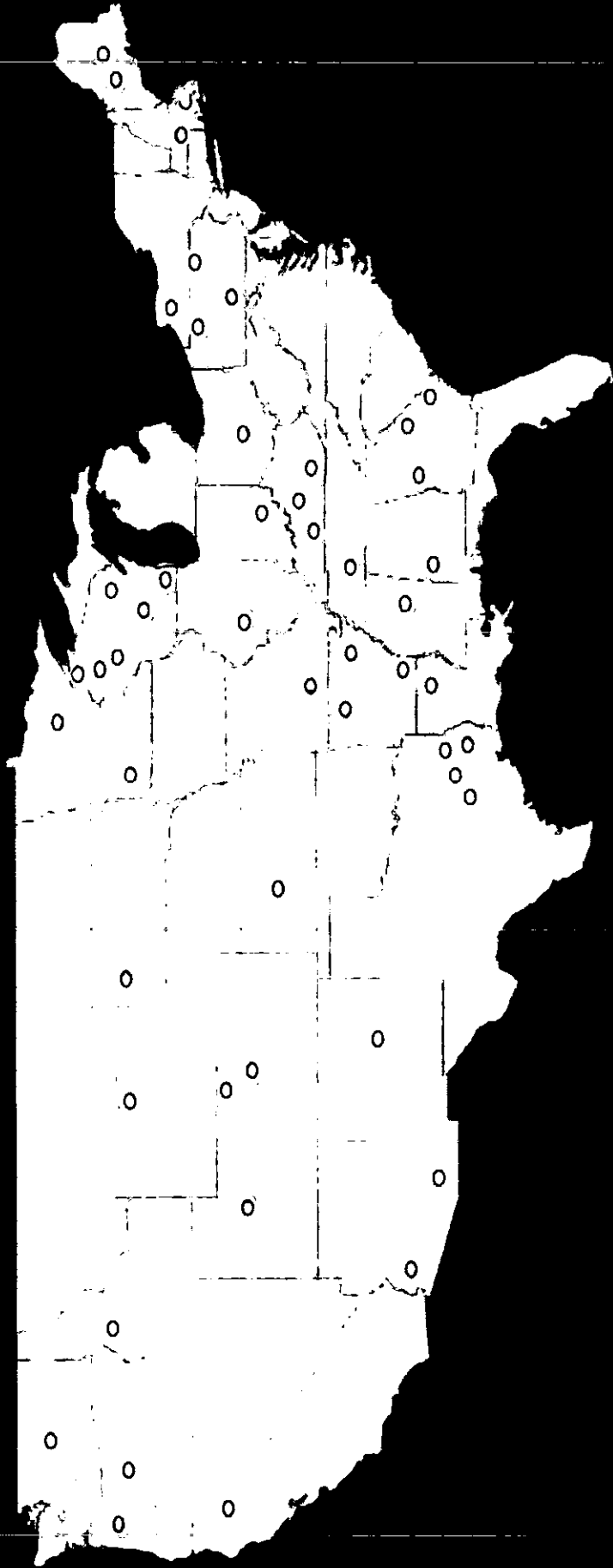

Bear Mountain Forest Products

Source: Stan Elliot, Wels 2009

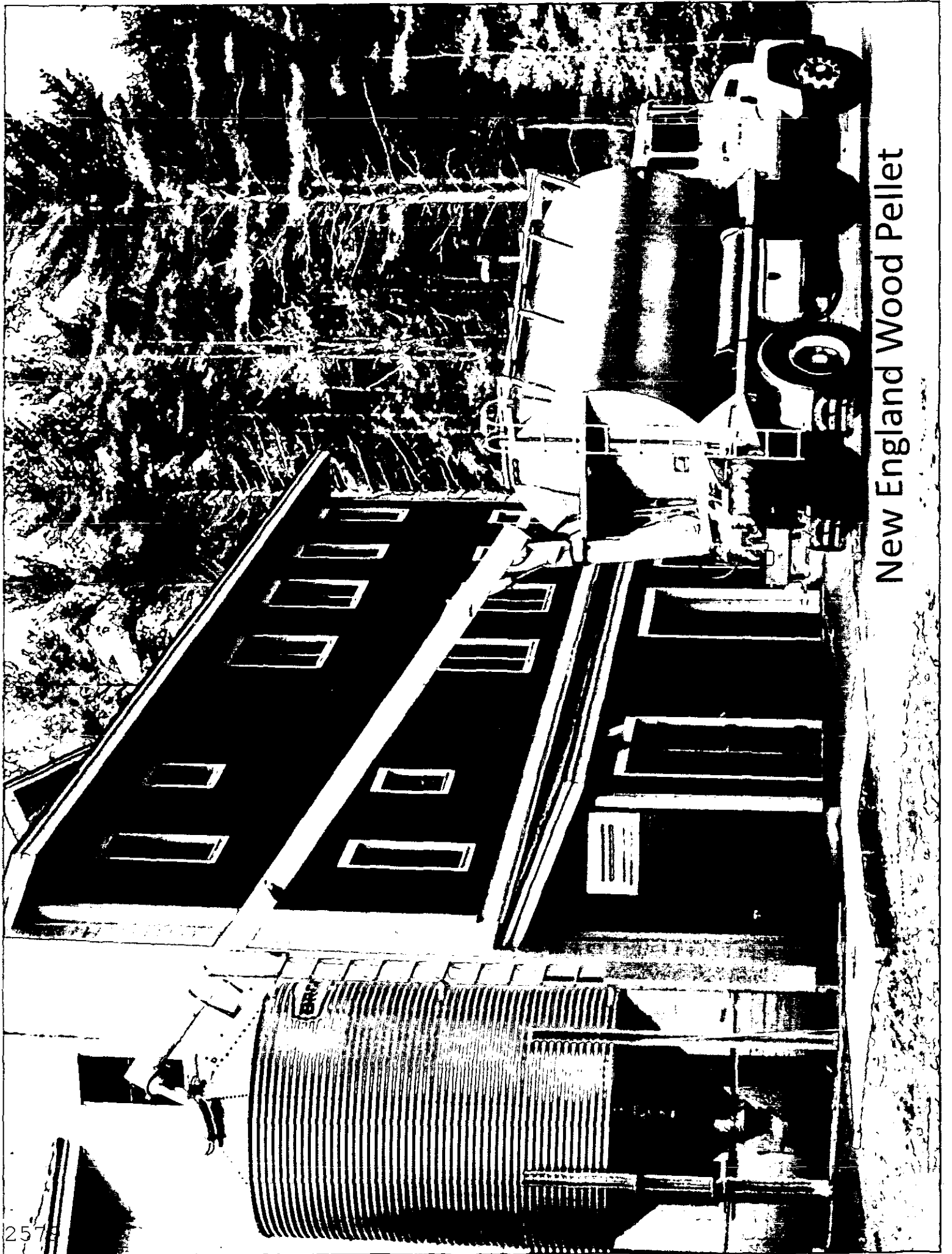

New England Wood Pellet

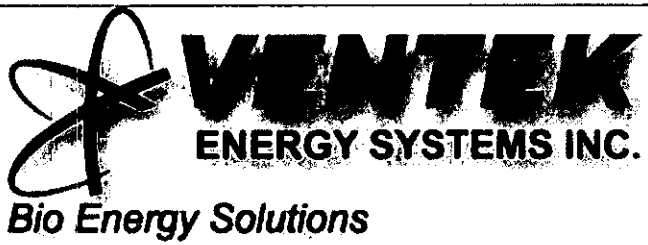

Approx. 30
Viessmann/KOB Boiler
systems now installed in N
America



Harney District Hospital, Burns OR Container System

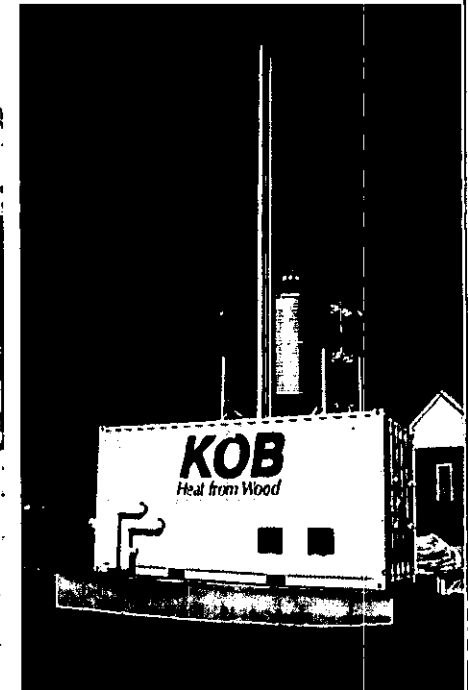



VENTEK
ENERGY SYSTEMS INC.

Bio Energy Solutions



A NATIVE CORPORATION
SEALASKA

Canadian pellet production

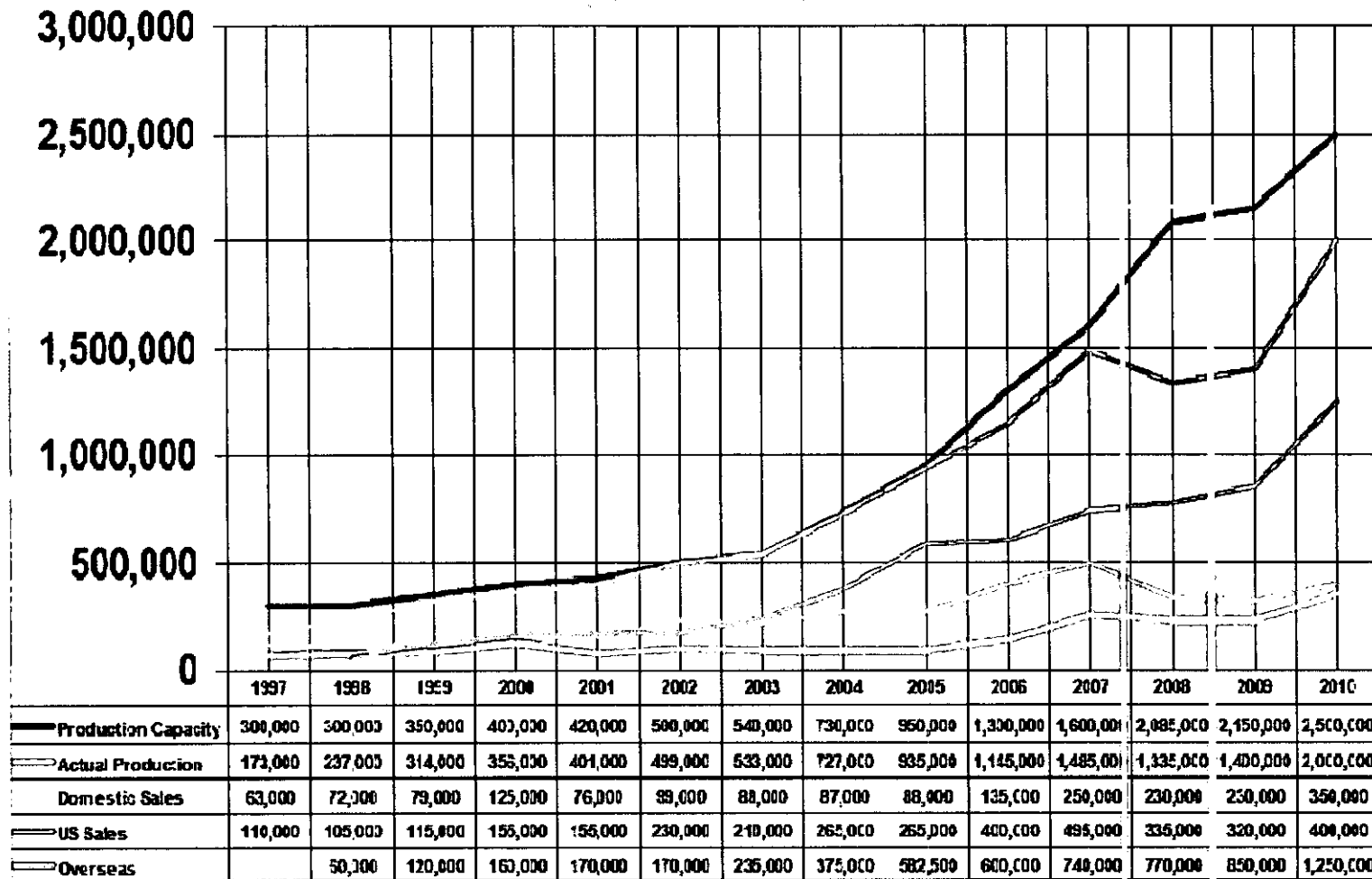

WOOD PELLET
ANNUAL REPORT 2010

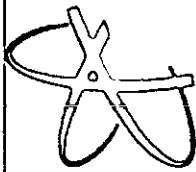

VENTEK
ENERGY SYSTEMS INC.

Bio Energy Solutions



A NATIVE CORPORATION
SEALASKA

Houston BC Pellet Plant
+/- 150,000 tons/yr.

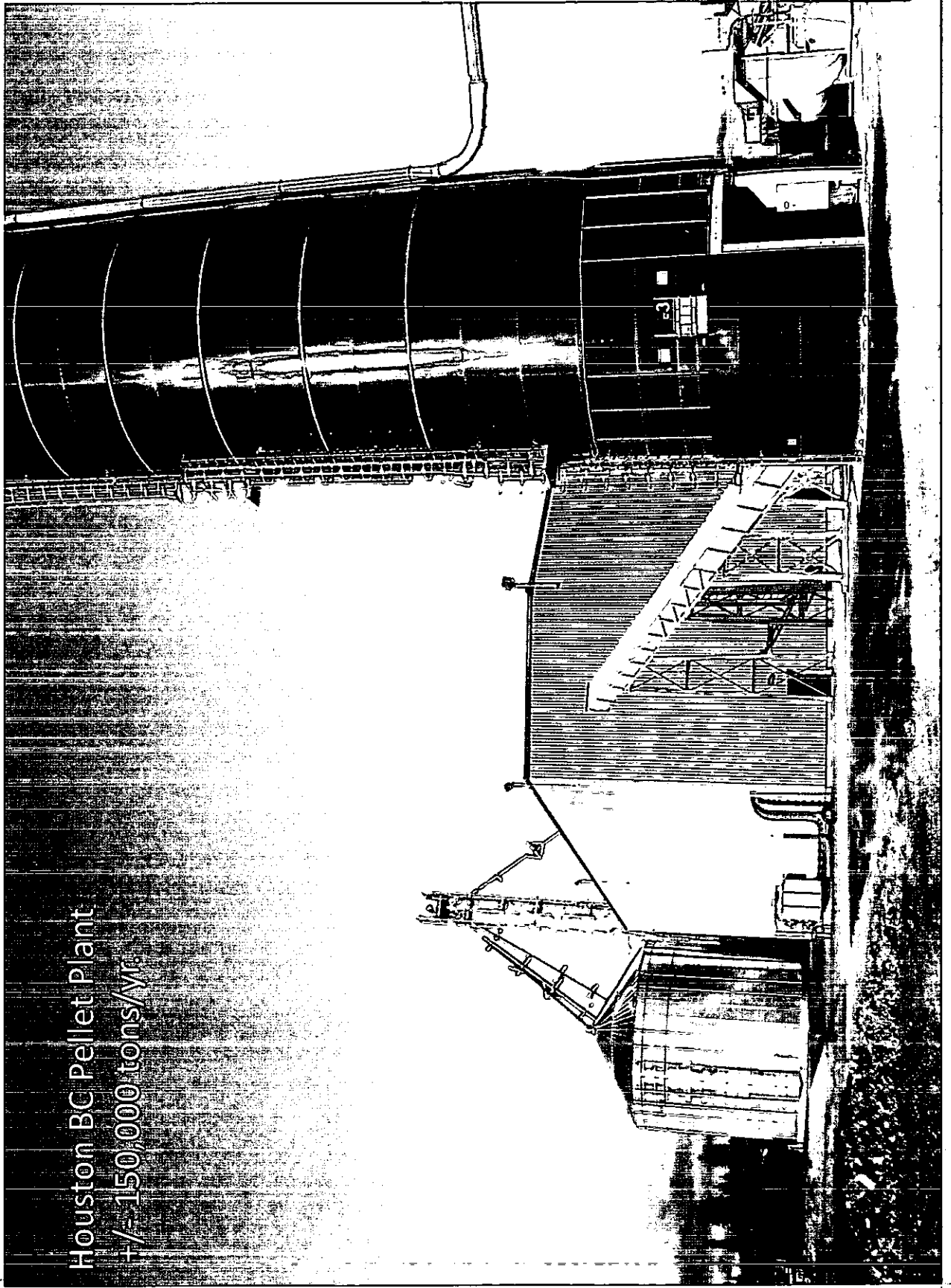

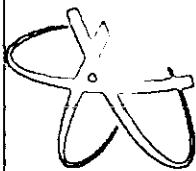

ENERGY SYSTEMS INC.

Bio Energy Solutions

2583

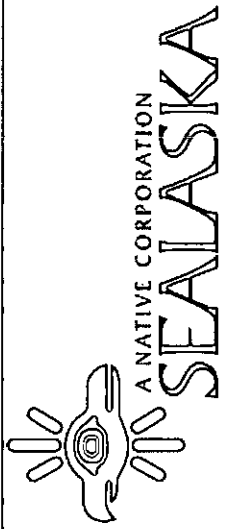

A NATIVE CORPORATION

SEALASKA

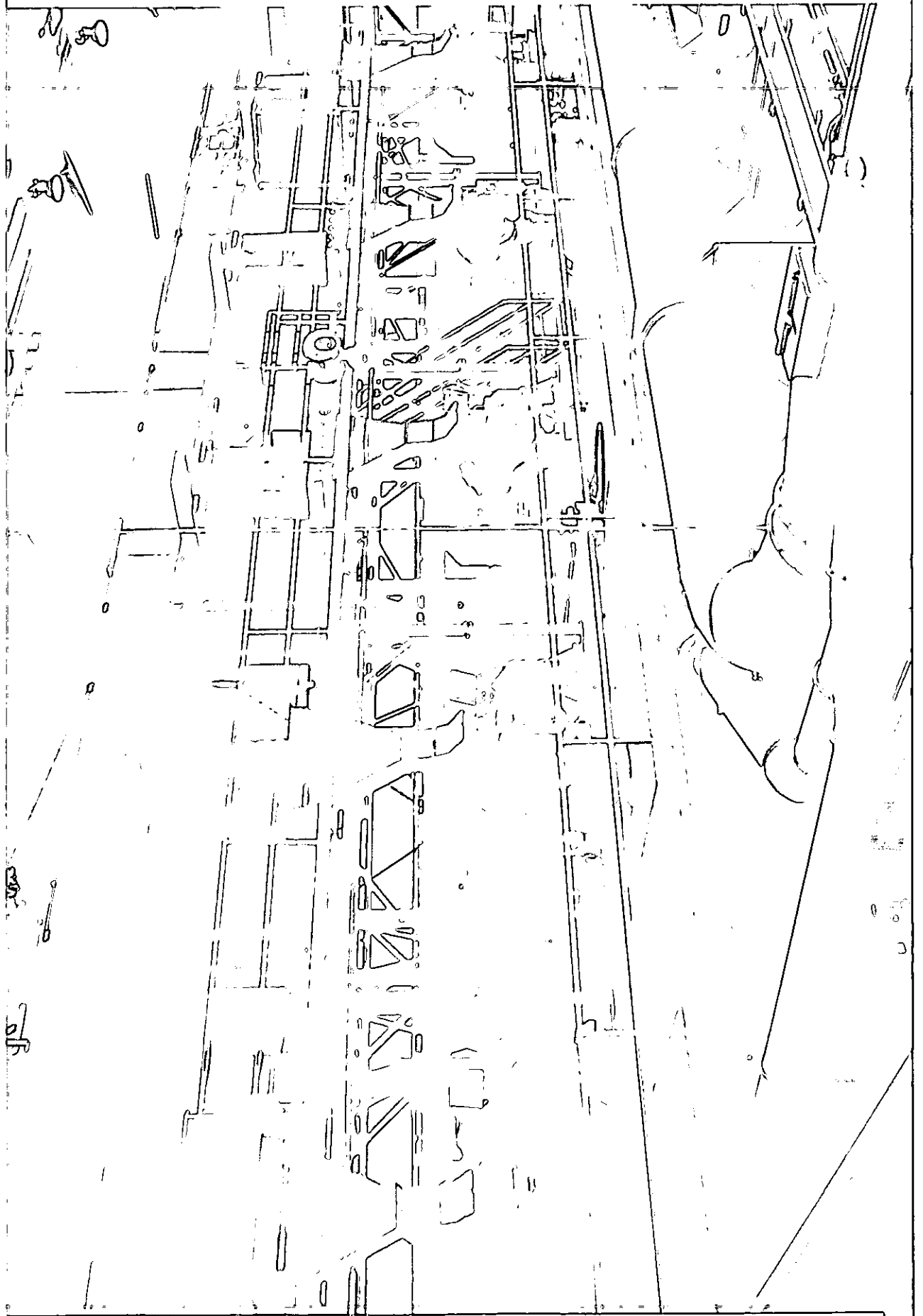



VENTEK

ENERGY SYSTEMS INC.

Bio Energy Solutions



A NATIVE CORPORATION

SEALASKA

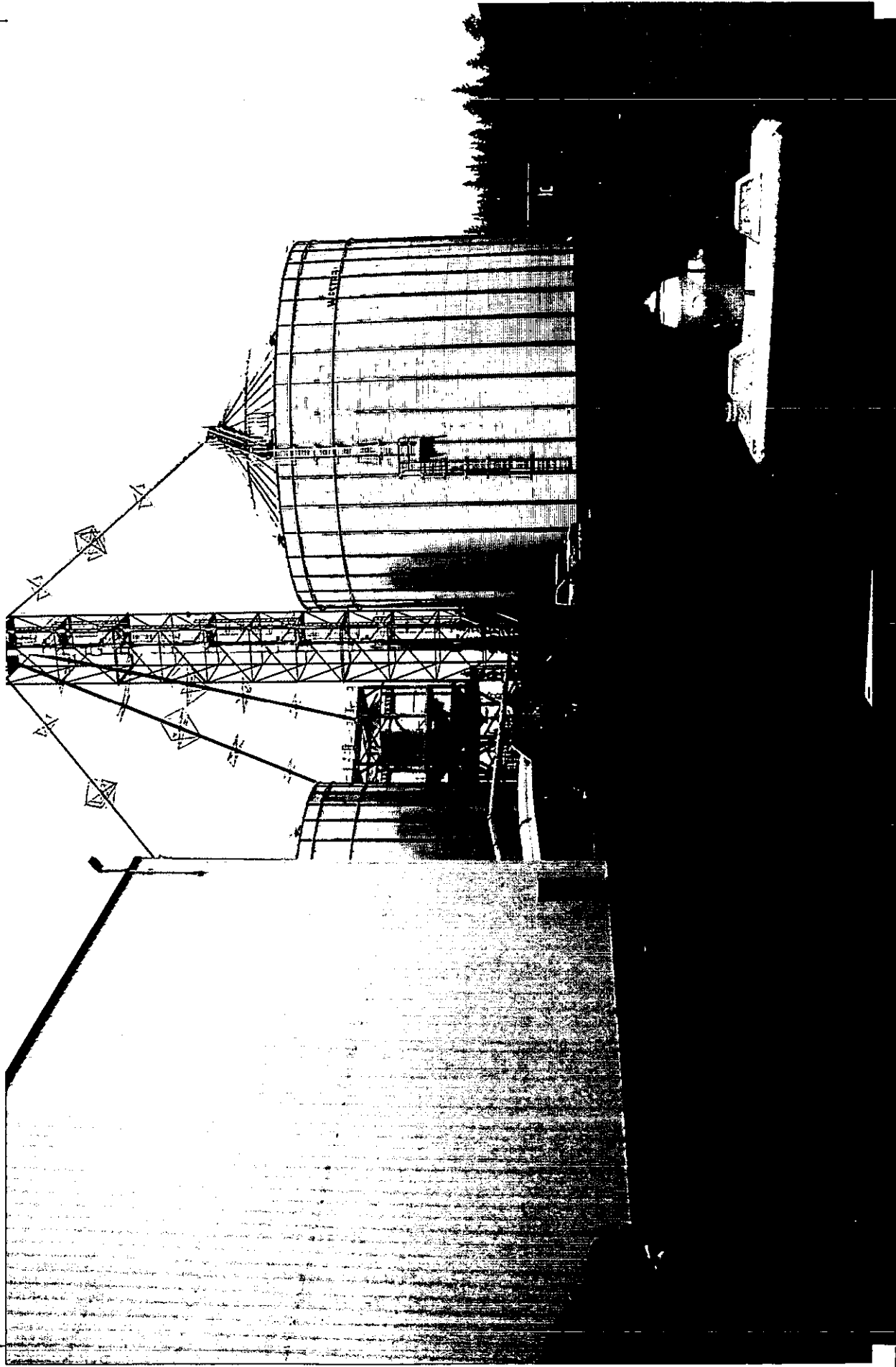



VENTEK

ENERGY SYSTEMS INC.

Bio Energy Solutions



A NATIVE CORPORATION
SEALASKA

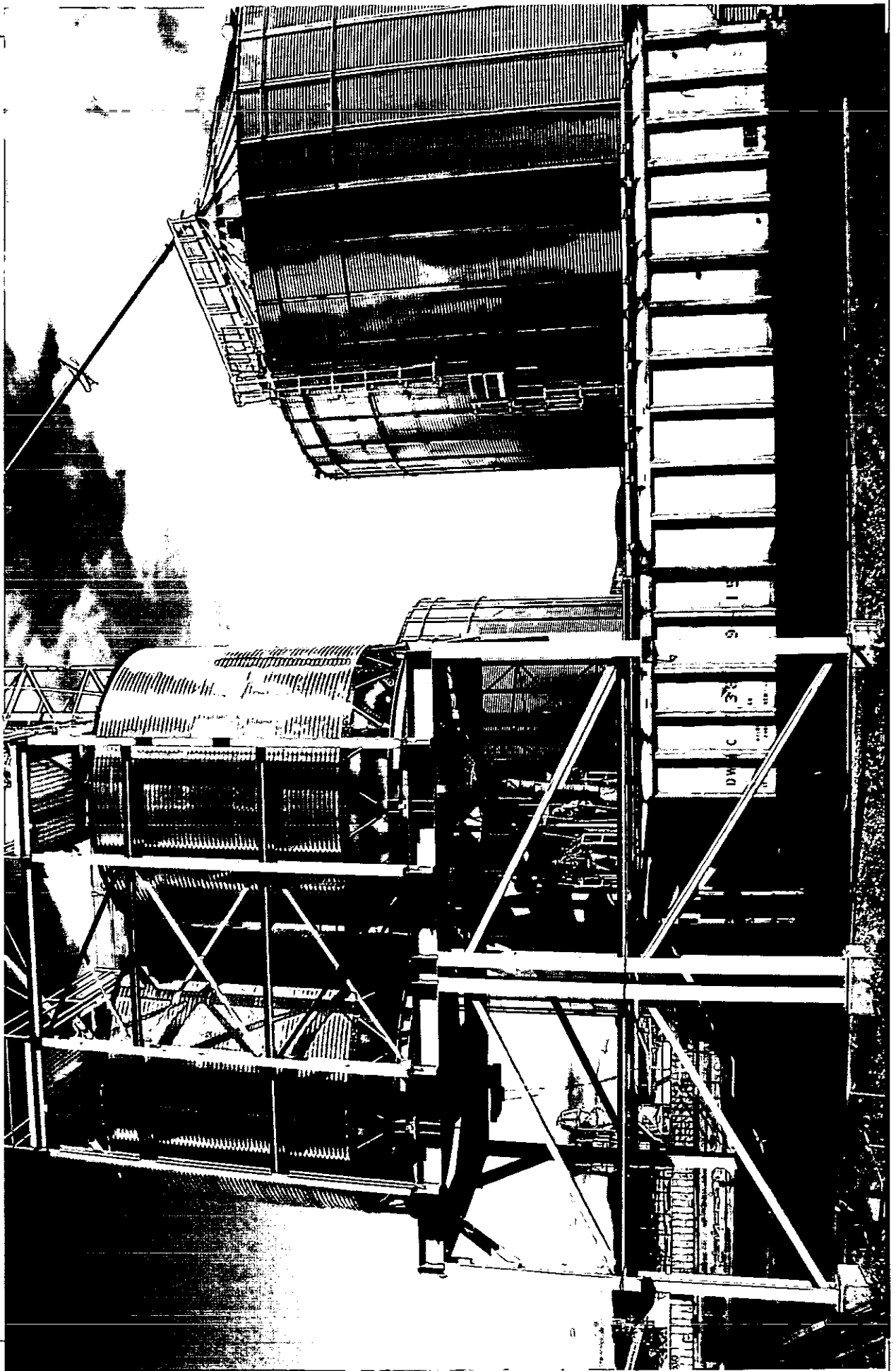

BC Pellet plant locations vs. Beetle Wood

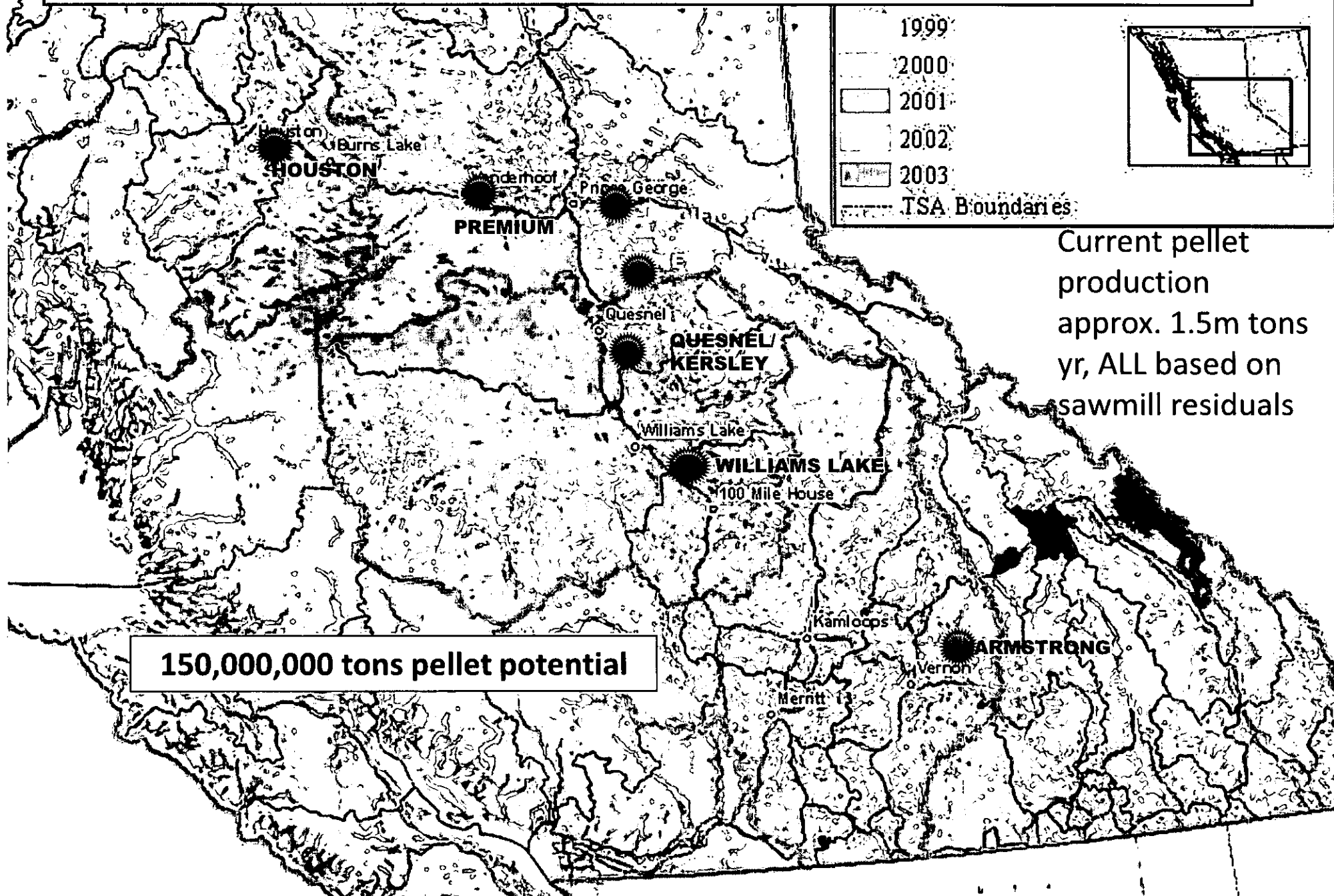

- 1999
- 2000
- 2001
- 2002
- 2003
- TSA Boundaries

Current pellet production approx. 1.5m tons yr, ALL based on sawmill residuals

150,000,000 tons pellet potential

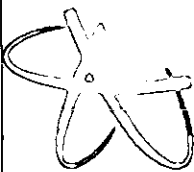

ENERGY SYSTEMS INC.

Bio Energy Solutions

2587

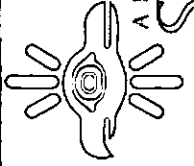

A NATIVE CORPORATION
SEALASKA

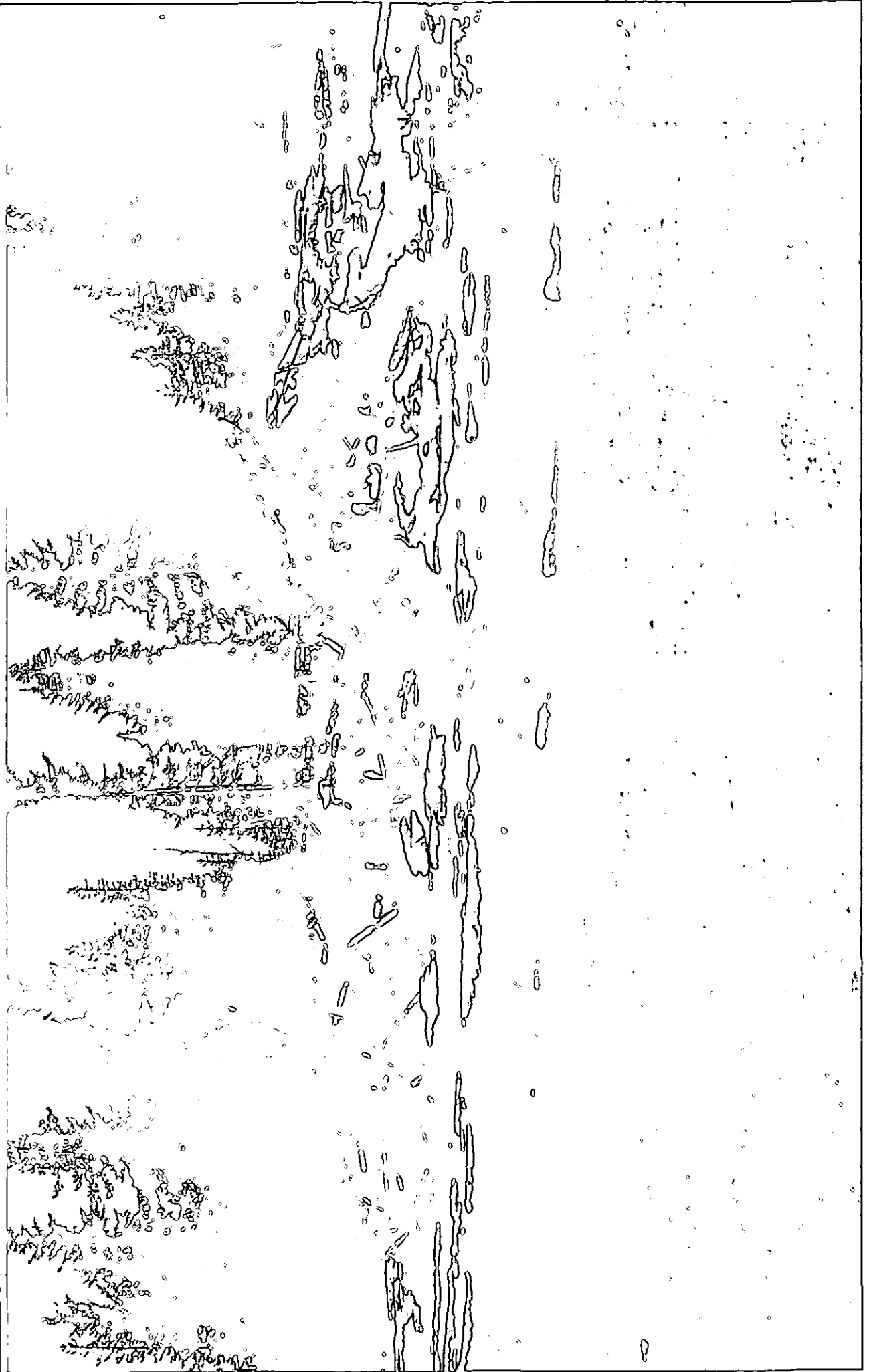

VENTTEK
ENERGY SYSTEMS INC.
Bio Energy Solutions

A NATIVE CORPORATION
SEALASKA





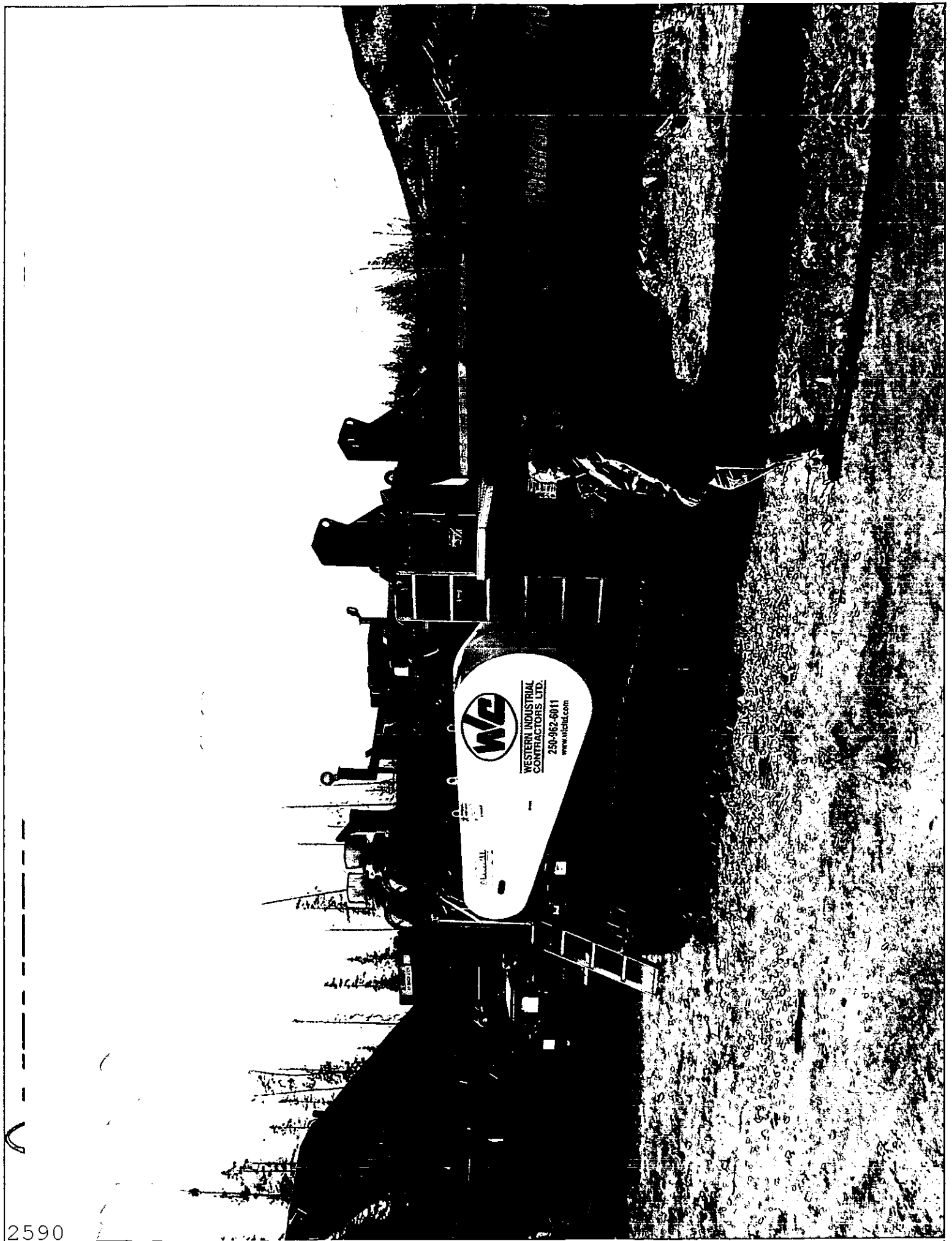

Type of Fuel	Rate as of July 1, 2008	Rate as of July 1, 2012
Gasoline	2.41 cents/litre	7.24 cents/litre (USD 0.26/Gal)
Diesel Fuel	2.76 cents/litre	8.27 cents/litre (\$0.30/Gal)
Natural Gas	49.88 cents/GJ	149.64 cents/GJ (\$141.84 per MMBH)
Light Fuel Oil	2.76 cents/litre	8.27 cents/litre (\$0.30/Gal)
Canadian bituminous coal	\$20.79/tonne	\$62.36/tonne (\$53.85/Ton)
Sub-bituminous coal	\$17.72/tonne	\$53.15/tonne (\$45.90/Ton)
Propane	1.54 cents/litre	4.62 cents/litre (\$0.17/Gal)



WENTTEK

ENERGY SYSTEMS INC.

Bio Energy Solutions



A NATIVE CORPORATION
SEALASKA

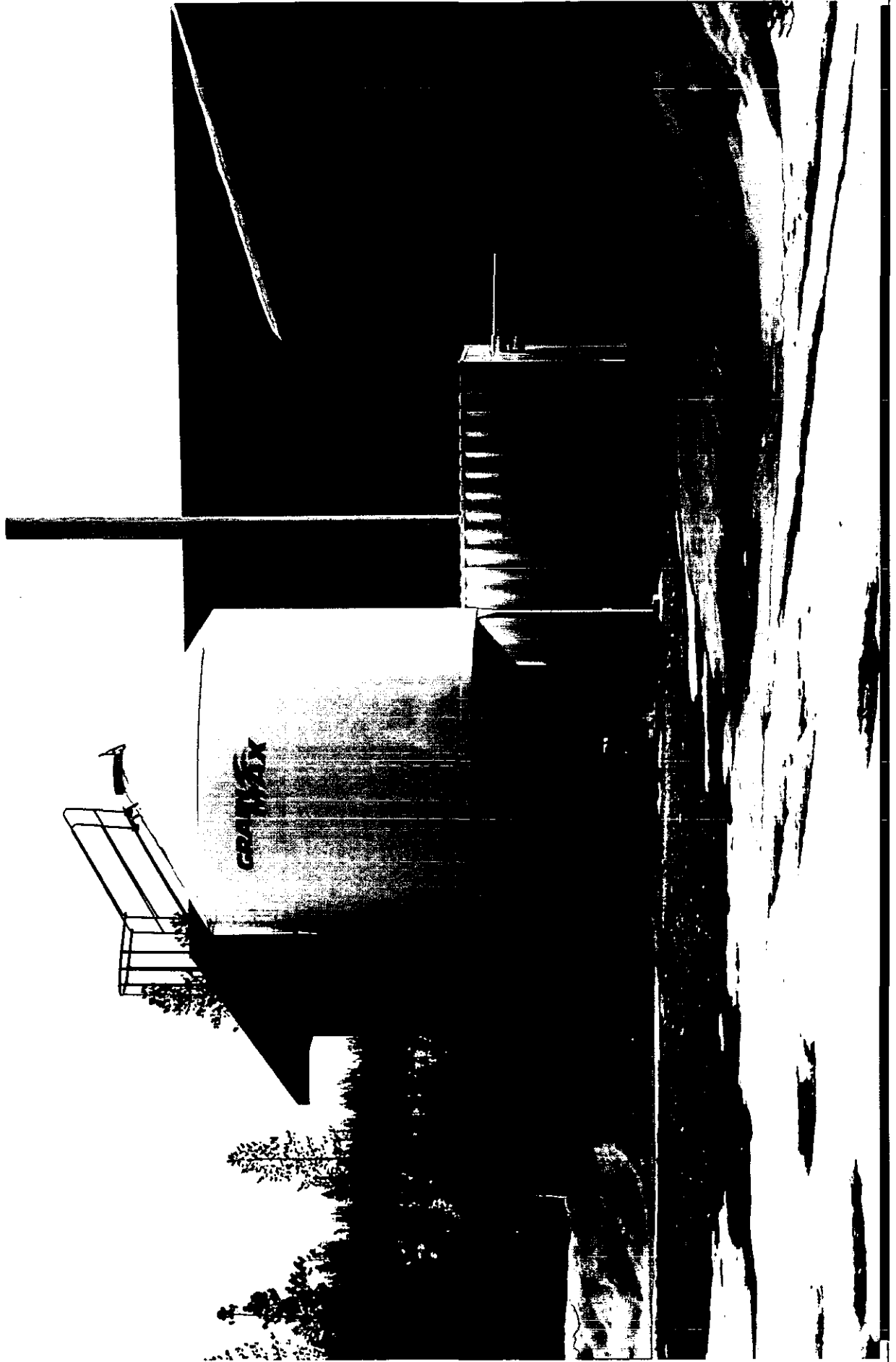

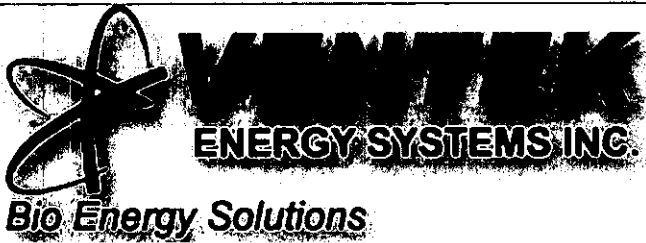

Nazko School Summary



- One of the first schools in Canada with 100% biomass heating – virtually 100% carbon neutral
- Net CO2 savings of 60 tons per year
- Displaces 8500 gallons of propane/yr.
- Fuel cost savings starting at \$10,000/yr - year one
- A model for the community, staff and students
- Local resource, local jobs, local suppliers (Pinnacle, Ventek)
- Eliminates \$1500/yr BC Carbon Tax (2012 onward)

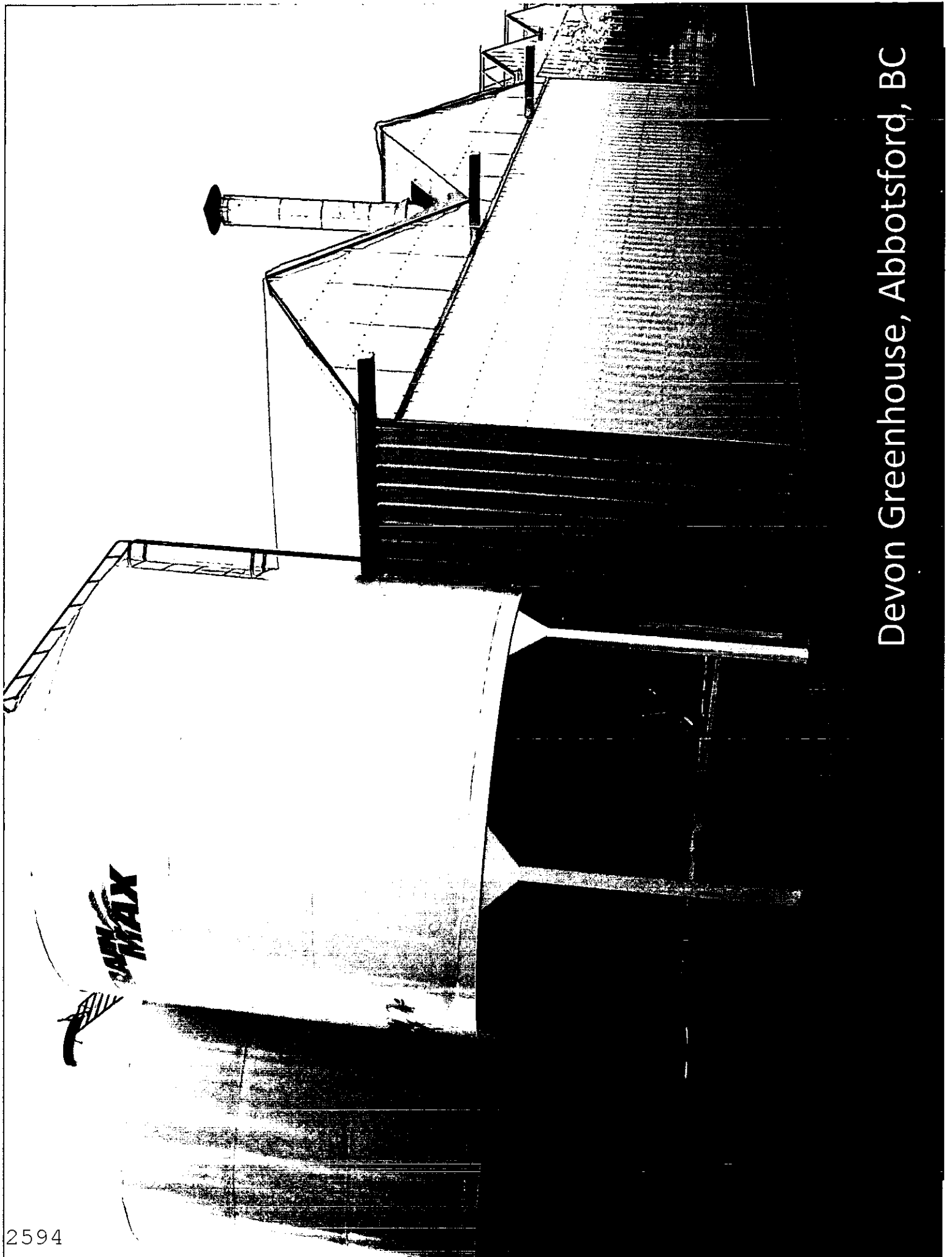

Devon Greenhouse, Abbotsford, BC

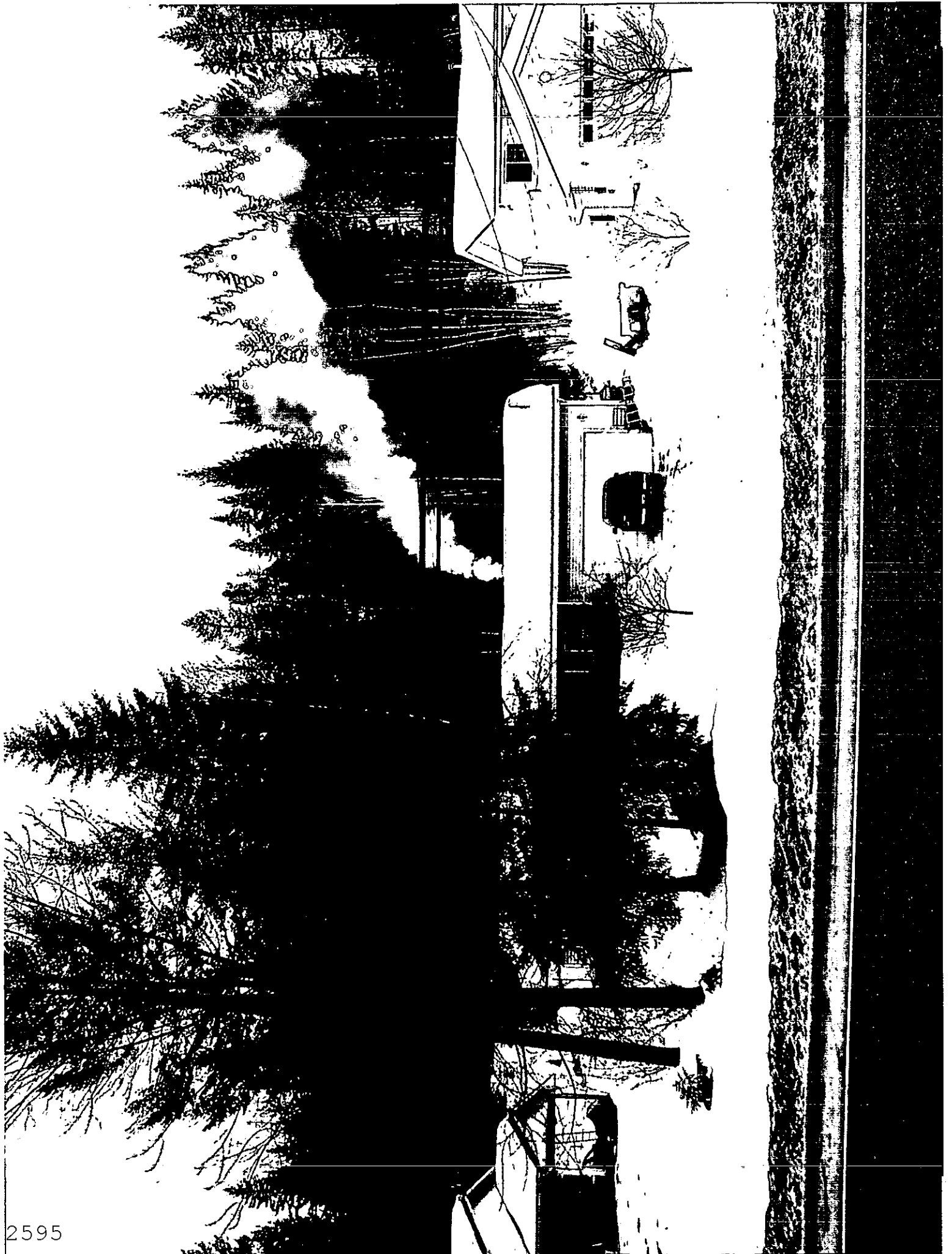

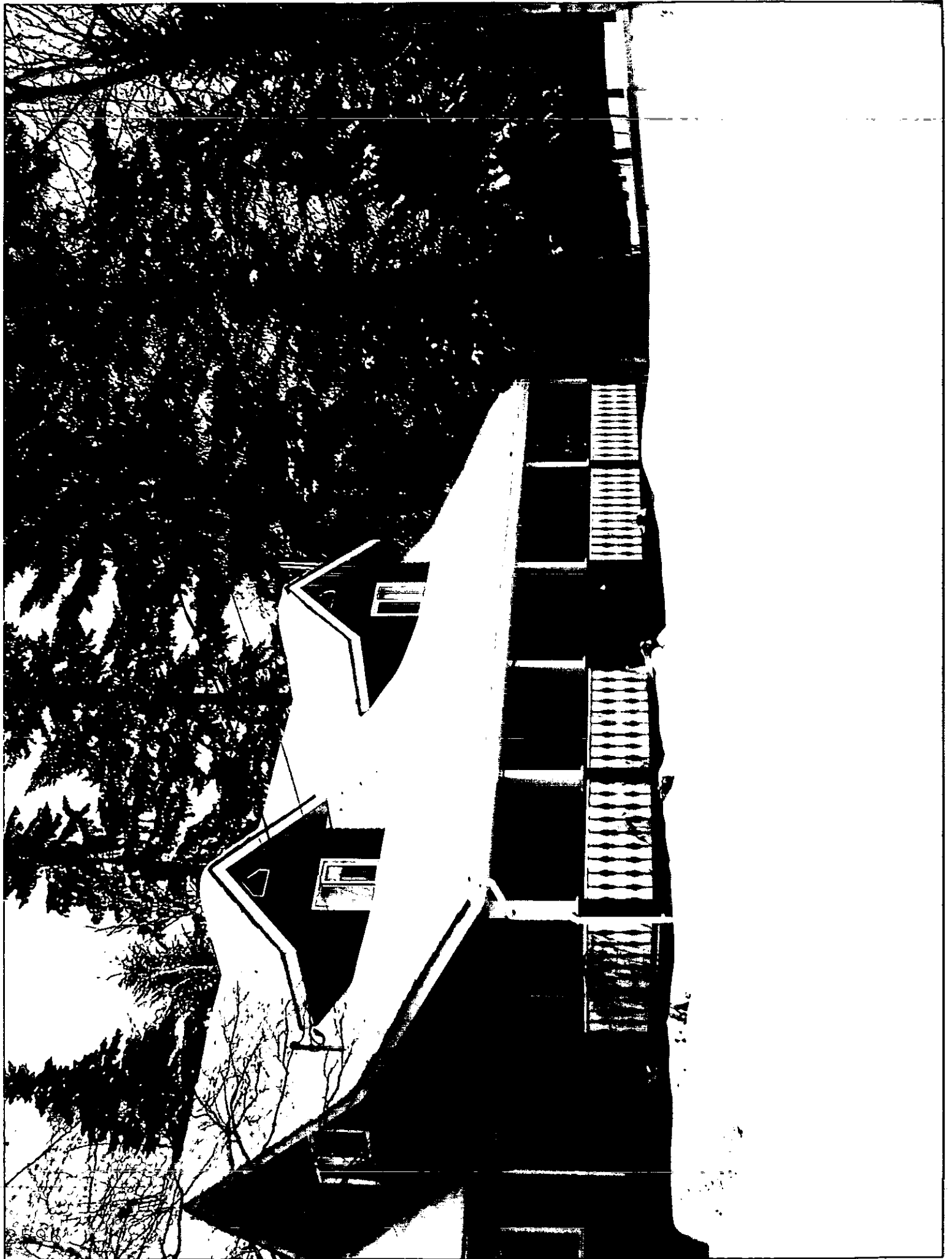

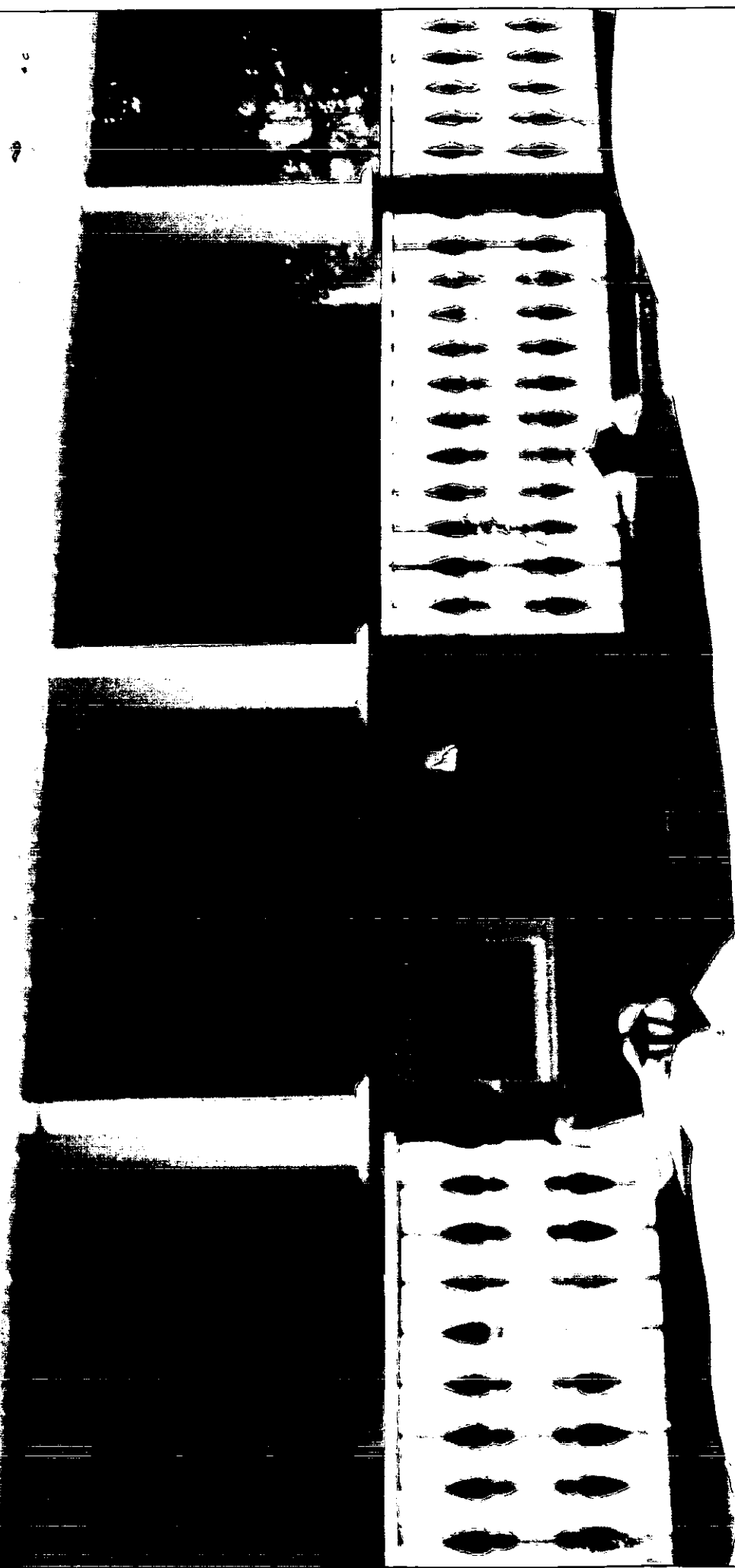

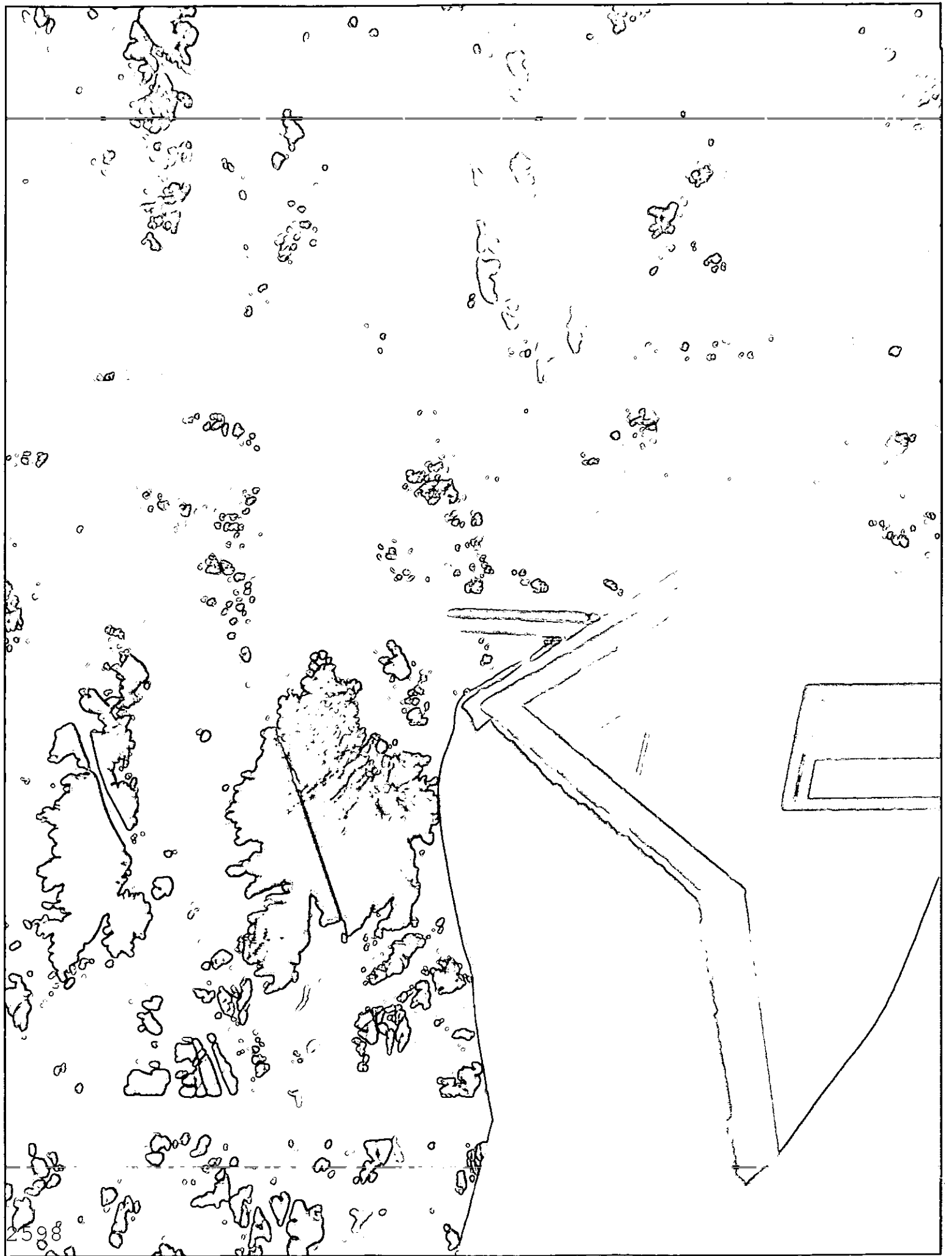

BIOMASS HEATING SYSTEMS FOR GNWT BUILDINGS

INSTALLED AND PLANNED WOOD PELLET BOILERS

OCTOBER 2009

Kalerni Dene School, N'Dilo
Three Bosch ME5ys 23 kW wood pellet boilers
Expected fuel of reduction of 30,000 litres per year
Expected GHG reduction of 80 tonnes
Installation completed in September 2009

North Slave Correctional Facility, Yellowknife
Two BINDER 750 kW wood pellet boilers
Fuel of reduction of 487,000 litres in 2008
GHG reduction of 1,390 tonnes in 2008
Installation completed in November 2008

Legislative Assembly Building, Yellowknife
One BINDER 300 kW wood pellet boiler
Expected fuel of reduction of 83,000 litres per year
Expected GHG reduction of 220 tonnes per year
Installation to be completed in 2008/10

Ecole St. Joseph School, Yellowknife
One KOB 540 kW wood pellet boiler
Expected fuel reduction of 102,000 litres per year
Expected GHG reduction of 270 tonnes per year
Installation completed in October 2008

Sr John Franklin School, Yellowknife
One BINDER 750 kW wood pellet boiler
Expected fuel reduction of 142,000 litres per year
Expected GHG reduction of 380 tonnes per year
Installation completed in February 2009

PWK School & Recreation Complex, Fort Smith
One KOB 750 kW wood pellet boiler
Expected fuel of reduction of 200,000 litres per year
Expected GHG reduction of 530 tonnes per year
Installation to be completed in 2010

Thebacha College, Fort Smith
One KOB 750 kW wood pellet boiler
Expected fuel of reduction of 200,000 litres per year
Expected GHG reduction of 530 tonnes per year
Installation to be completed in 2010

Health Centre, Fort Smith
One KOB 750 kW wood pellet boiler
Expected fuel of reduction of 200,000 litres per year
Expected GHG reduction of 530 tonnes per year
Installation to be completed in 2010

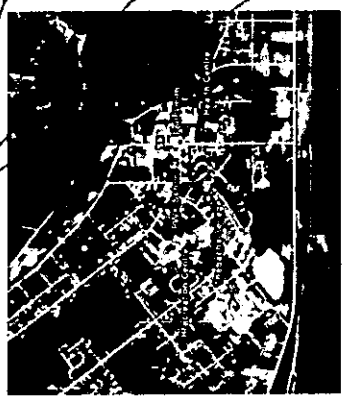
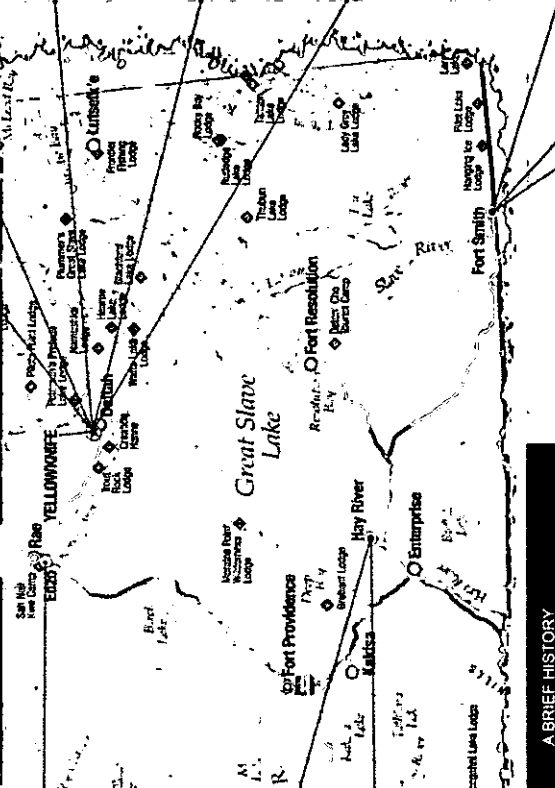
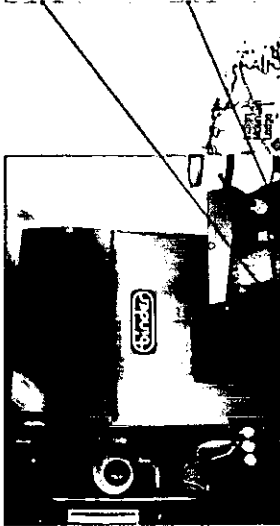

A BRIEF HISTORY

The first wood pellet boilers for a Territorial Government building were installed at the North Slave Correctional Centre in 2006. Arctic Green Energy (AGE) owns and installed the boiler, and sells heat to the Government of the NWT (GNWT). Thanks to the success of that project, the GNWT is now investing in its own wood pellet boilers for other facilities, where economically viable.

Since the cost to transport wood pellets is higher than that of other fuels, the most viable locations for wood pellet boilers are those closest to the source of wood pellets. Currently, that source is in La Crete in northern Alberta. Therefore, the GNWT is investing in wood pellet boilers in communities on the road network in the South and North Slave regions.



Chief Jimmy Brunneau School, Behchoko
One KOB 780 kW wood pellet boiler
Expected fuel of reduction of 153,000 litres per year
Expected GHG reduction of 410 tonnes per year
Installation completed in October 2008

Highways Maintenance Garage, Hay River
One KOB 280 kW wood pellet boiler
Fuel of reduction of 100,000 litres per year
Expected GHG reduction of 270 tonnes per year
Installation to be completed in 2010

Central Heating Plant Serving Four Schools, Hay River
One KOB 1 MW wood pellet boiler
Expected fuel oil and propane reduction equivalent to 318,000 litres of fuel oil per year
Expected GHG reduction of 850 tonnes per year
Installation to be completed in 2010

Diamond Jewellers School & new Tradeshop
Henry Carmel School
Ecole Borowale
Princess Alexandra School

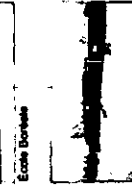
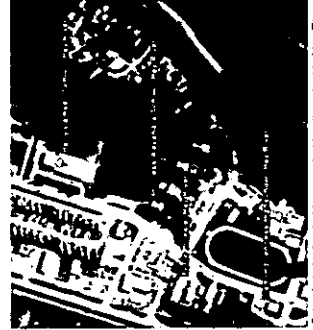

Princess Alexandra School

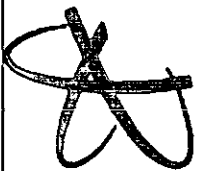

MENTEK
ENERGY SYSTEMS INC.

Bio Energy Solutions

Yellowknife
Apartment
System



A NATIVE CORPORATION
SEALASKA

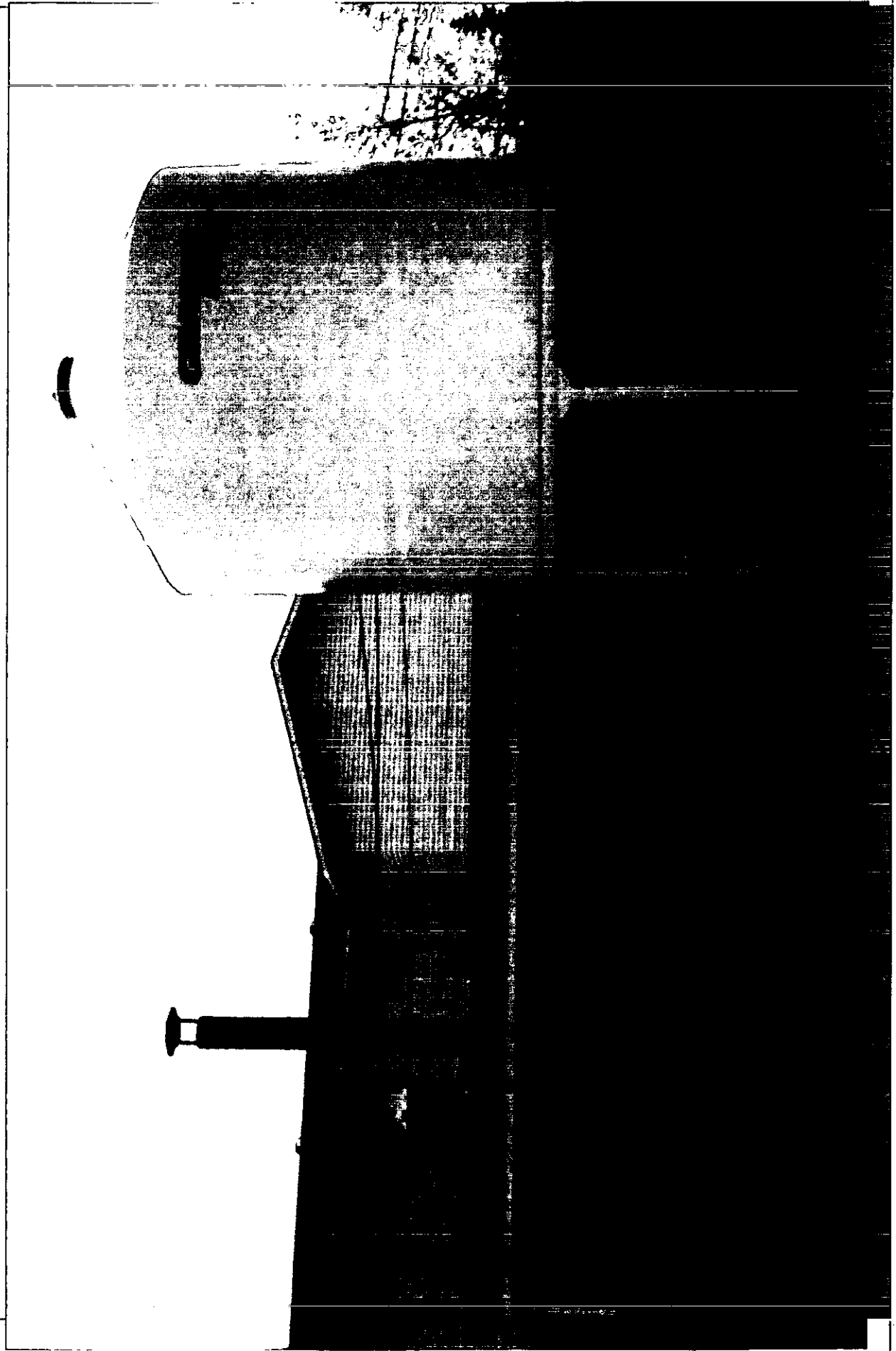



Bio Energy Solutions

VENTTEK

ENERGY SYSTEMS INC.



A NATIVE CORPORATION

SEALASKA

Yellowknife Apartments,
Boiler and Storage

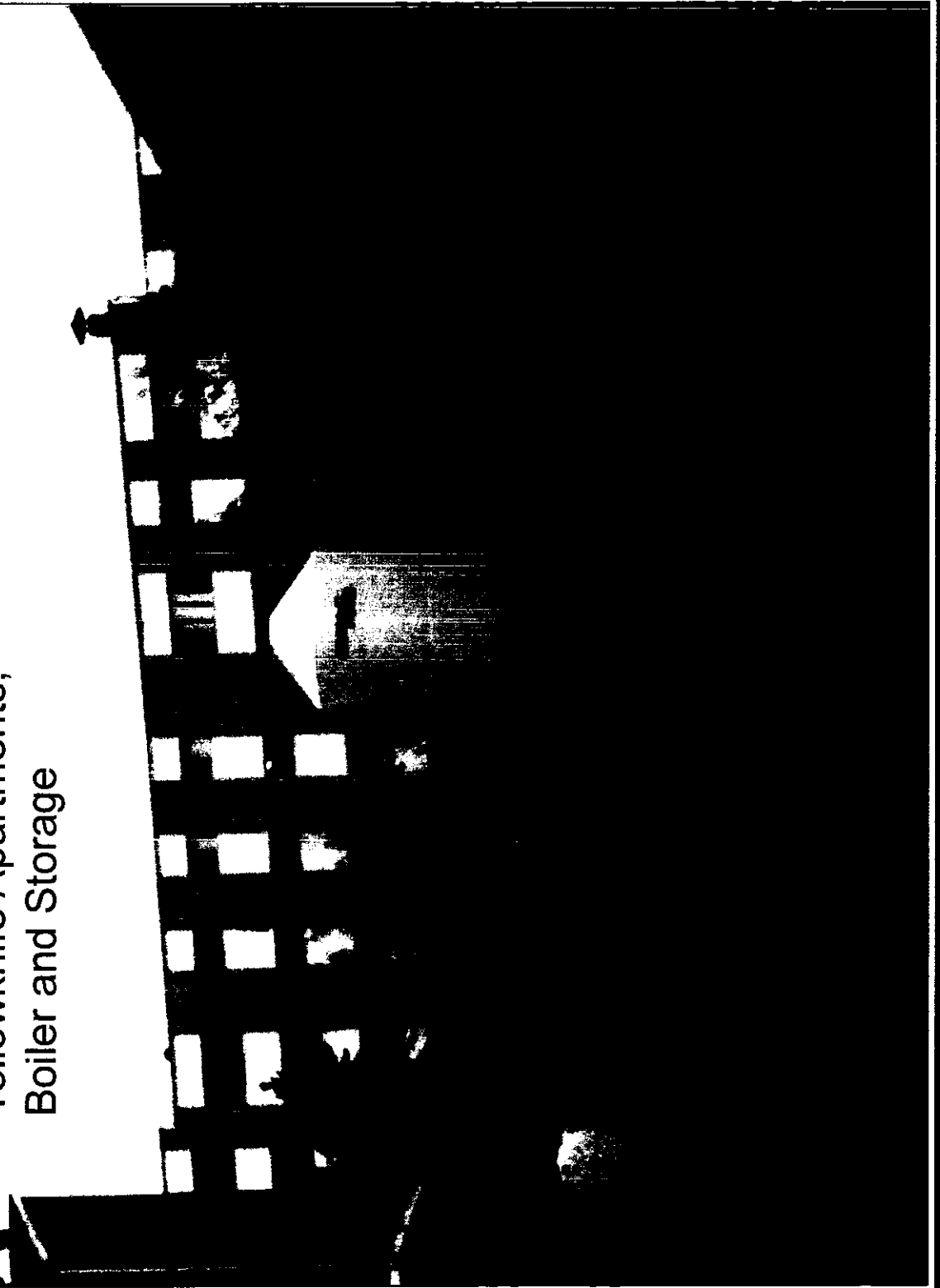



Bio Energy Solutions

VENTEK
ENERGY SYSTEMS INC.



A NATIVE CORPORATION
SEALASKA

Yellowknife Swimming Pool, District Heating

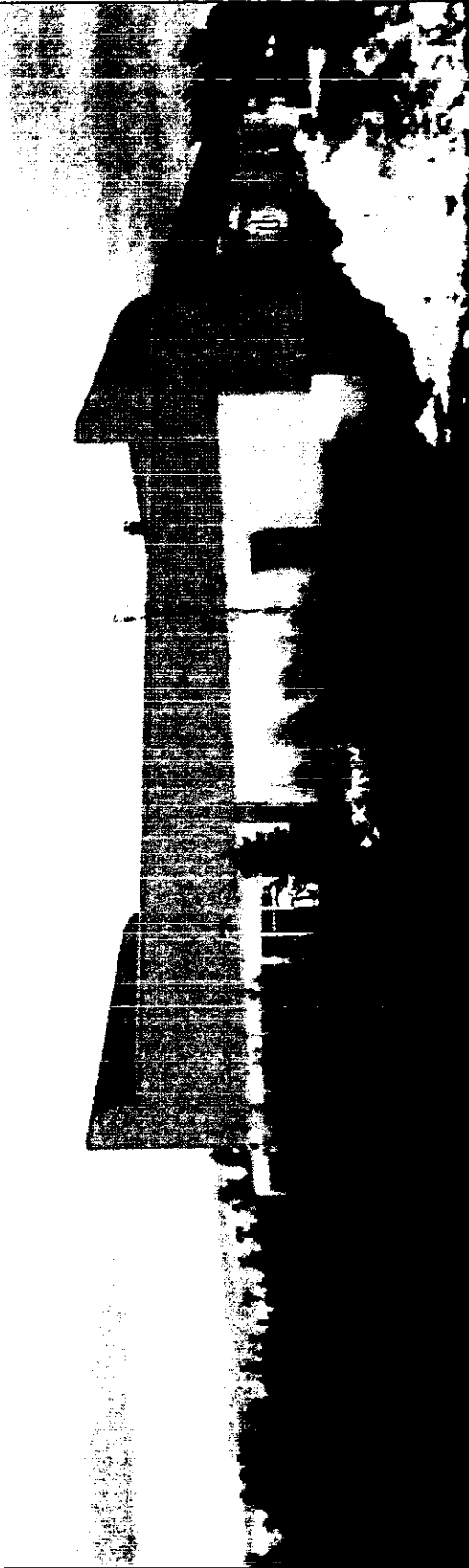

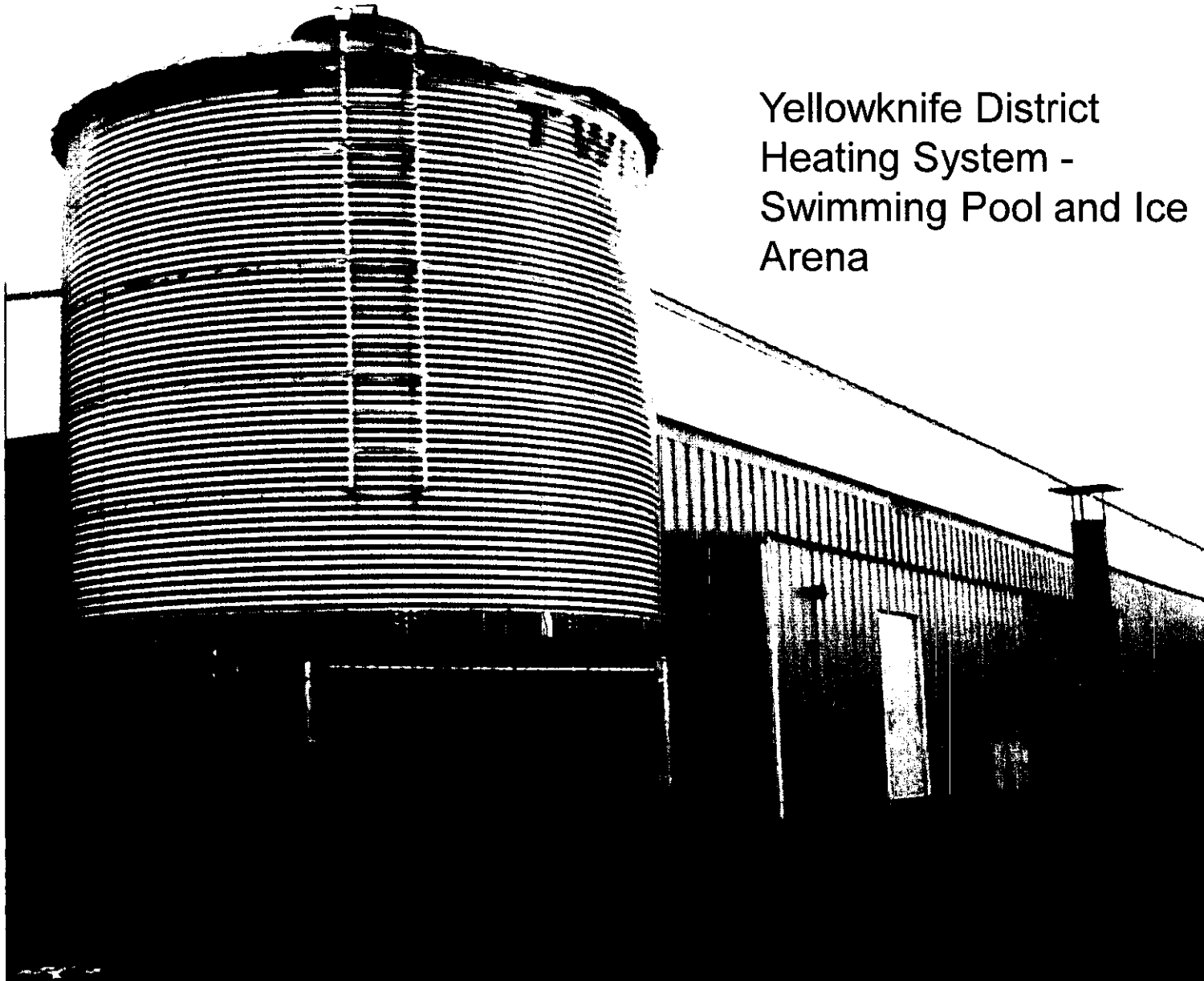

Yellowknife District
Heating System -
Swimming Pool and Ice
Arena

New School
Installation
being
completed in
Yellowknife

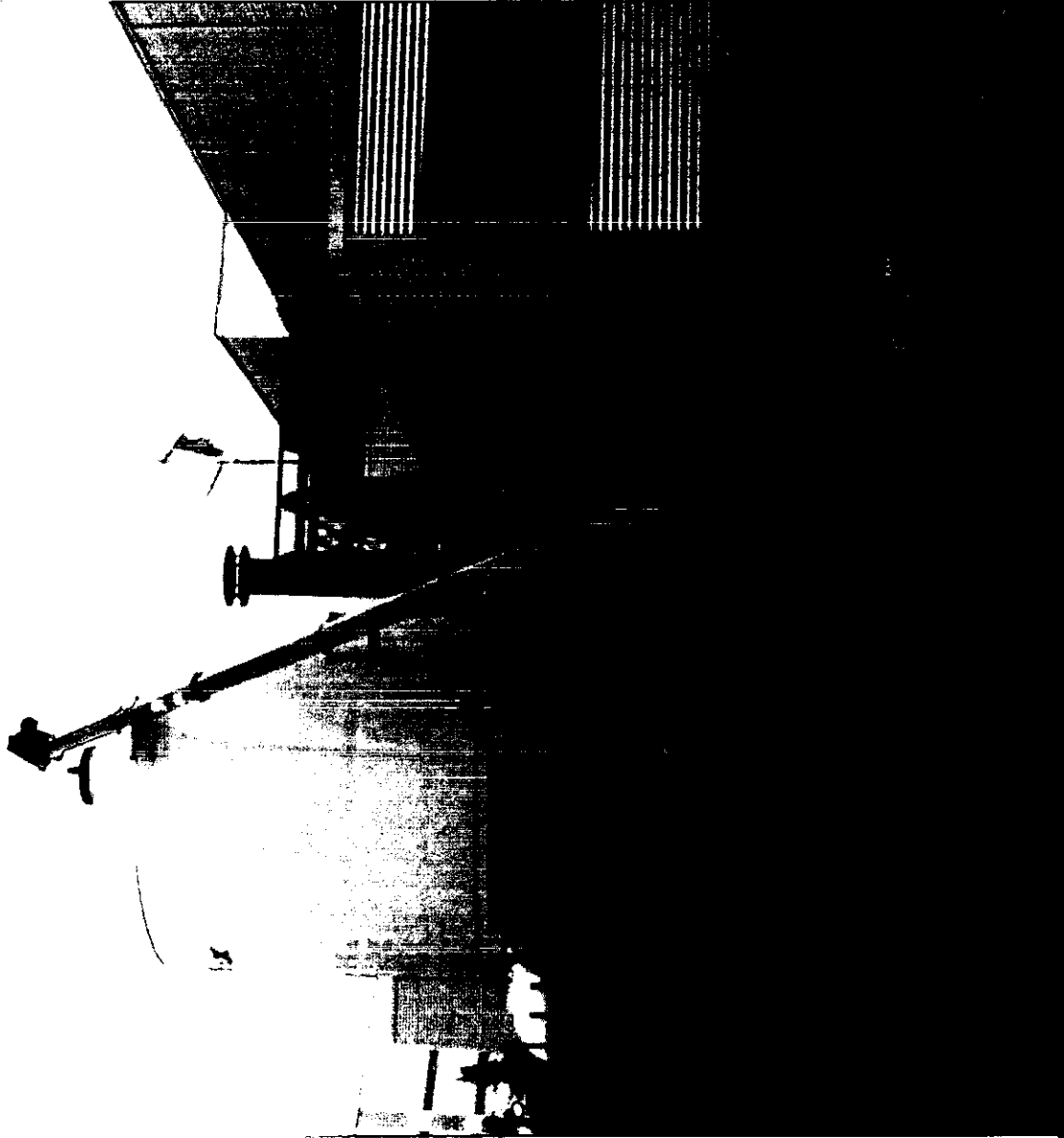



VENTEK
ENERGY SYSTEMS INC.

Bio Energy Solutions



A NATIVE CORPORATION
SEALASKA

NWT Legislative Building
Being converted to wood
pellet heating system



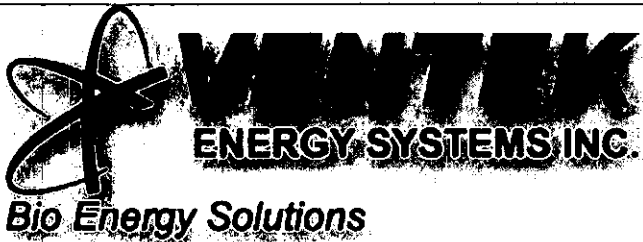

Northwest Territory Summary:

425,000 sq/mi – 35,000 residents

(vs Alaska 586,000 sq/mi, +/- 600,000 residents)

- Approx. 15 commercial biomass boiler installations
- Many residential wood pellet stoves (up to 50% fuel savings vs oil/propane).
- **12,000 tons/yr** of pellet consumption, for a population base of 35,000, in just 4 years!

Yukon Summary:

186,000 sq/mi – 33,500 residents

(vs Alaska 586,000 sq/mi, +/- 600,000 residents)

Enough dead trees from forest wild fires annually to supply 600,000 tons of wood pellets/yr (10% would supply the entire thermal needs of every Yukon building!

- Approx. 6 commercial biomass boiler installations in planning stage, including Dawson City and Yukon Corrections Facility
- Growing number of residential wood pellet stoves, up to 50% fuel savings vs oil/propane.
- **1,000 tons/yr** of pellet consumption, (want to catch-up to NWT!)

Bob and Donna
 Supernault, Delta Junction
 Largest Harman Stove Dealer
 In Pac NW
 #100 stoves/yr
 #1000 tons pellets/yr



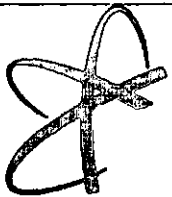

VENTEK
ENERGY SYSTEMS INC.

Bio Energy Solutions



A NATIVE CORPORATION
SEALASKA



Typical Pellet Stove,
Residential Installation
Harman Stove

Current US Federal Tax
Credit, 30% up to
\$1500 per installation

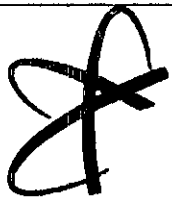

VENTEK
ENERGY SYSTEMS INC.

Bio Energy Solutions



A NATIVE CORPORATION
SEALASKA

New Superior Pellet Plant, Fairbanks
10,000 tons production, up to 60,000
Start-up, summer 2010



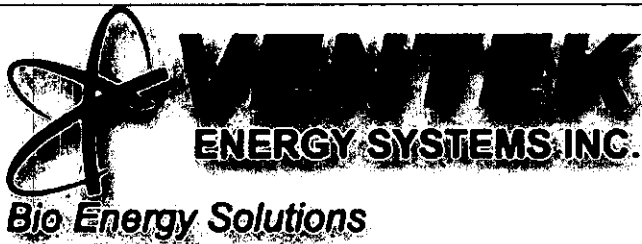

Pellet Opportunity for SE...

**Wood pellet fuel = 30% saving for the average heating bill,
based on today's price of oil**

(does anyone expect oil prices to decrease?)

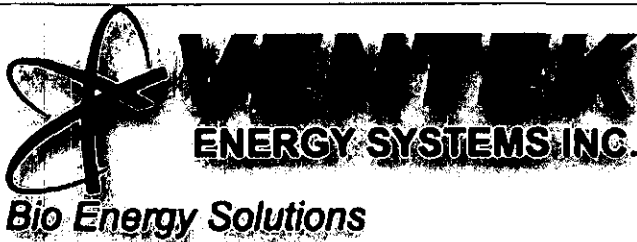

Pellet Opportunity for SE...

**30% saving for the average heating bill,
based on import wood pellets**

**Viking Lumber planning 15,000 ton/yr pellet plant,
currently seeking equipment and funding.**

**Viking Lumber currently has approx. 10,000 tons/yr of
residual waste**

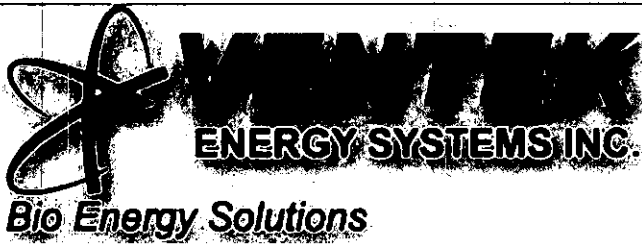

Pellet Opportunity for SE...

Wood pellet stoves, commercial sized boilers and distribution is now readily available.

There is no plan to harvest the Tongass for biomass – thinning and residuals would provide enough feedstock.

Imports will continue to be available as necessary.

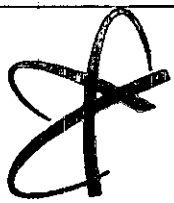

VENTEK
ENERGY SYSTEMS INC.

Bio Energy Solutions

- KOB Boilers – 30 years in Austria
- Now part of Viessmann, excellent reputation globally (33 countries, 6800 employees)

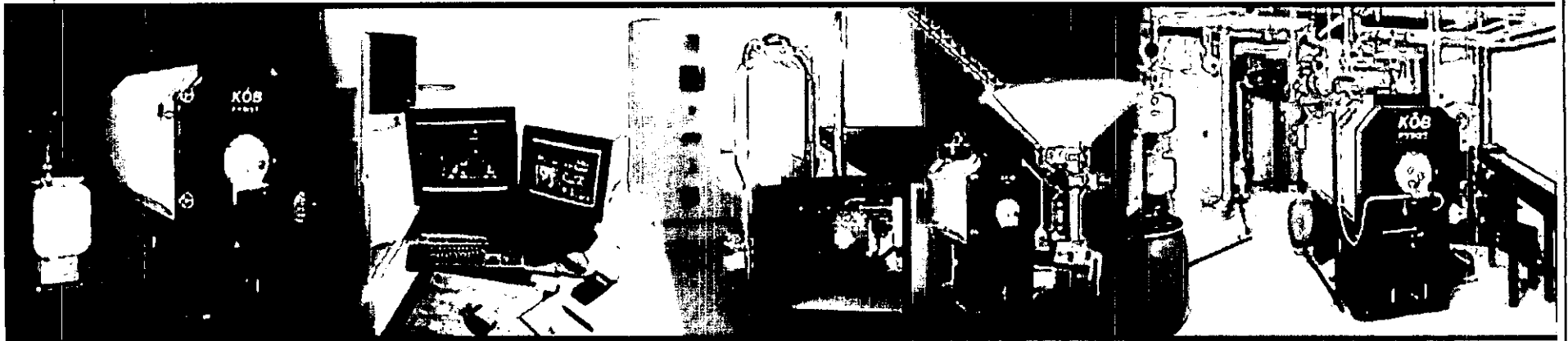
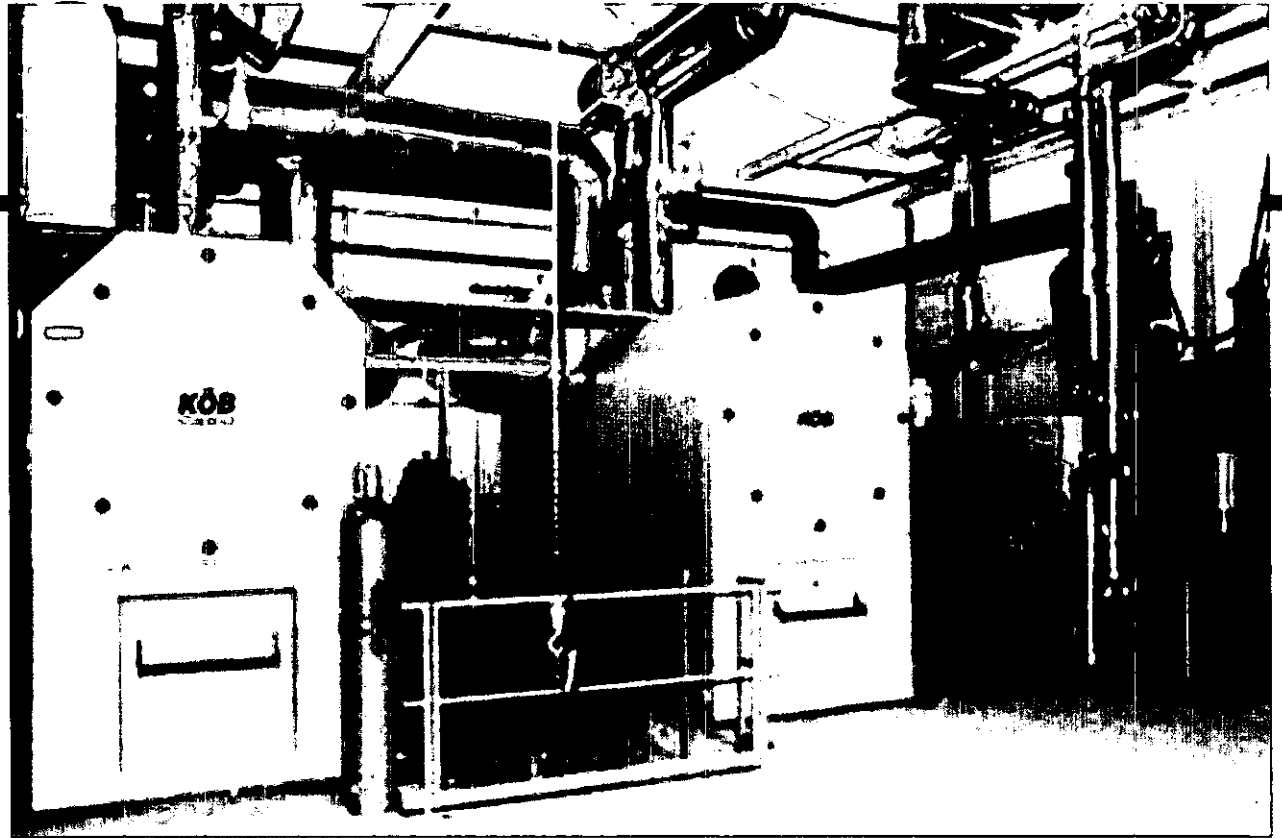

KOB/Viessmann Boiler

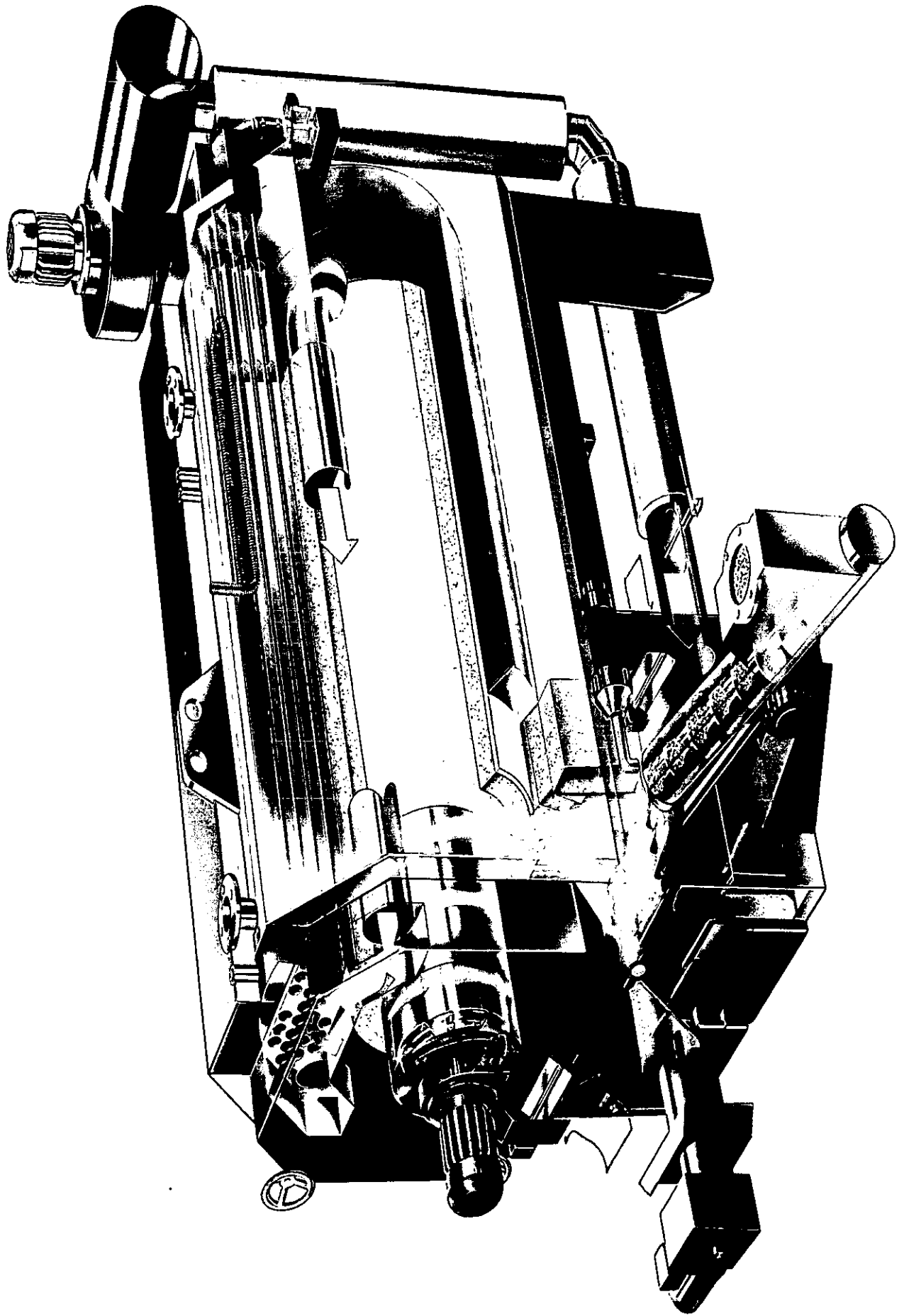

SUMMARY

- Wood pellet demand, as a preferred “green” fuel in N America, is expected to grow dramatically in the future.
- Prices will remain stable as the market matures, compared to the volatility of fossil fuels.
- There is an abundance of raw material in N America.
- Developing wood pellet applications in Alaska will create jobs, reduce carbon emissions, save money, and....

“It’s the right thing to do!”