

SB

329

**SENATE COMMITTEE REPORT
First Committee of Referral**

DATE: 2/13/04

FURTHER: Finance

Date of 5-Day Notice: _____
(in accordance with Uniform Rule 23)

DATE TURNED
IN TO OFFICE: 3-25-04

Resources Committee considered SENATE BILL NO. 329

SB 329 NUISANCE MOOSE

"An Act relating to control of nuisance moose."

and recommends:

- be replaced with _____ CS SB 329 (RES)
- adopt previous _____ CS _____ (_____)
- attached amendment(s)
- adopt Letter of Intent by _____ Committee
- further referral to _____ Committee

Senate Bill:	
<input checked="" type="checkbox"/>	Same Title
<input type="checkbox"/>	New Title
House Bill:	
<input type="checkbox"/>	Same Title
<input type="checkbox"/>	Technical Title Change
<input type="checkbox"/>	New Title w/ SCR # _____

NEW FISCAL NOTE(S):

Department	Date	Fiscal	Indet.	Zero	FN#
F&C	3/25/04			✓	
new note forthcoming					

PREVIOUS FISCAL NOTE(S):

Department	Date	Fiscal	Indet.	Zero	FN#

APPROPRIATION - no fiscal note

SIGNATURES AND RECOMMENDATIONS:	DO PASS	DO NOT PASS	NO REC	AMEND
<i>John P. ...</i>	✓			
<i>...</i>	✓			
<i>Ben ...</i>	✓			
<i>...</i>	✓			
CHAIR: <i>...</i>	✓			

FISCAL NOTE

STATE OF ALASKA
2004 LEGISLATIVE SESSION

Fiscal Note Number: _____
 Bill Version: CSSB 329 (RES)
 () Publish Date: _____

Revision Date/Time (Note if correction): _____ Dept. Affected: Fish and Game
 Title Nuisance Moose RDU Wildlife Conservation
 Component Wildlife Conservation
 Sponsor Senator Bunde
 Requester Senate Finance Component No. 473

Expenditures/Revenues (Thousands of Dollars)

Note: Amounts do not include inflation unless otherwise noted below.

OPERATING EXPENDITURES	FY 2005	FY 2006	FY 2007	FY 2008	FY 2009	FY 2010
Personal Services						
Travel						
Contractual						
Supplies						
Equipment						
Land & Structures						
Grants & Claims						
Miscellaneous						
TOTAL OPERATING	0.0	0.0	0.0	0.0	0.0	0.0

CAPITAL EXPENDITURES						
-----------------------------	--	--	--	--	--	--

CHANGE IN REVENUES ()						
-------------------------------	--	--	--	--	--	--

FUND SOURCE (Thousands of Dollars)

1002 Federal Receipts						
1003 GF Match						
1004 GF						
1005 GF/Program Receipts						
1037 GF/Mental Health						
Other (Specify Type--Do not abbreviate)						
TOTAL	0.0	0.0	0.0	0.0	0.0	0.0

Estimate of any current year (FY2004) cost: 0.0

Mark this box (X) if funding for this bill is included in the Governor's FY 2005 budget proposal:

POSITIONS

Full-time						
Part-time						
Temporary						

ANALYSIS: (Attach a separate page if necessary)

Passage of this legislation would have no fiscal impact.

Prepared by: Sarah Gilbertson, Legislative Liaison Phone 465-6137
 Division Alaska Department of Fish & Game Date/Time 3/25/04 2:48 PM
 Approved by: Commissioner Kevin Duffy Date 3/25/2004
 Agency Alaska Department of Fish & Game

FISCAL NOTE

STATE OF ALASKA
2004 LEGISLATIVE SESSION

Fiscal Note Number: _____
 Bill Version: S.B. 329
 () Publish Date: _____

Revision Date/Time (Note if correction): _____ Dept. Affected: Fish & Game
 Title Control of Nuisance Moose RDU Wildlife Conservation
 Component Wildlife Conservation
 Sponsor Senator Bunde (by request)
 Requester Senate Resources Component No. 473

Expenditures/Revenues (Thousands of Dollars)

Note: Amounts do not include inflation unless otherwise noted below.

OPERATING EXPENDITURES	FY 2005	FY 2006	FY 2007	FY 2008	FY 2009	FY 2010
Personal Services	19.8	19.8	19.8	19.8	19.8	19.8
Travel	0.0	0.0	0.0	0.0	0.0	0.0
Contractual	150.0	150.0	150.0	150.0	150.0	150.0
Supplies	35.0	35.0	35.0	35.0	35.0	35.0
Equipment	5.0	5.0	5.0	5.0	5.0	5.0
Land & Structures	0.0	0.0	0.0	0.0	0.0	0.0
Grants & Claims	0.0	0.0	0.0	0.0	0.0	0.0
Miscellaneous	0.0	0.0	0.0	0.0	0.0	0.0
TOTAL OPERATING	209.8	209.8	209.8	209.8	209.8	209.8
CAPITAL EXPENDITURES	0.0	0.0	0.0	0.0	0.0	0.0
CHANGE IN REVENUES	0.0	0.0	0.0	0.0	0.0	0.0

FUND SOURCE (Thousands of Dollars)

1002 Federal Receipts						
1003 GF Match						
1004 GF						
1005 GF/Program Receipts						
1037 GF/Mental Health						
Other (Fish and Game Fund)	209.8	209.8	209.8	209.8	209.8	209.8
TOTAL	209.8	209.8	209.8	209.8	209.8	209.8

Estimate of any current year (FY2004) cost: 0.0
 Check this box (X) if funding for this bill is included in the Governor's FY 2005 budget proposal:

POSITIONS

Full-time						
Part-time						
Temporary						

ANALYSIS: *(Attach a separate page if necessary)*
 Expenditures reflect the assumption that 100 moose, which is roughly 10% of the moose in the Anchorage bowl, would be moved annually. Costs will vary greatly depending on what is considered to be "a practicable alternative" for translocating moose.

The cost per moose is estimated to be between \$1,500 and \$2,000. This includes drugs for capture and immobilization during transport, helicopter, airplane, and truck expenses, and other costs such as crates, ear tags, etc. Total estimated relocation costs are shown. Personnel costs are equivalent to 1/3 of a year of biologist and/or veterinarian time.

(Continued on Page 2)

Prepared by: Matt Robus, Director Phone 465-4190
 Division Wildlife Conservation Date/Time 3/24/04 11:30 AM
 Approved by: Commissioner Kevin Duffy Date 3/24/2004
 Agency Alaska Department of Fish & Game

FISCAL NOTE

STATE OF ALASKA
2004 LEGISLATIVE SESSION

BILL NO. S.B. 329

ANALYSIS CONTINUATION

If a third party is authorized to participate, some costs could decrease. However, the department's involvement would still be substantial, since the drugs involved are closely controlled substances and our personnel would have to remain involved with the capture and maintenance of animals being moved.



SENATOR SCOTT OGAN

23RD Alaska State Legislature

Senate District H Lazy Mountain * Butte * Chugiak * Peters Creek * Fairview Loop

Knik-Goose Bay * Big Lake * Houston * Willow * Talkeetna * Trapper Creek

State Capitol, Room 103, Juneau Alaska 99801 * (907) 465-3878 * 1 (800) 862-3878 * Fax (907) 465-3265

Senator_Scott_Ogan@legis.state.ak.us

Http://www.akrepublicans.org/ogan

FACSIMILE TRANSMITTAL SHEET

TO: Leg legal FROM: Linda Hay - Sec Res. # 103

COMPANY: DATE: 3-25-04

FAX NUMBER: 2029 TOTAL NO. OF PAGES INCLUDING COVER: 3

PHONE NUMBER: RE: CS for SB 329

URGENT FOR REVIEW PLEASE COMMENT PLEASE REPLY PLEASE RECYCLE

NOTES/COMMENTS:

please prepare a Senate Resource
 + deliver
 Comm CS for SB 329 -

delete "a" as indicated on attached
 document + I believe Department
 is also new text from original version -
 Please call if there are
 questions -

PROPOSED CS for SENATE BILL NO. 329

"An Act relating to control of nuisance moose."

BE IT ENACTED BY THE LEGISLATURE OF THE STATE OF ALASKA:

* Section 1. AS 16.05 is amended by adding a new section to read:

Sec. 16.05.052. Nuisance moose. The Department [COMMISSIONER] shall avoid destruction of nuisance moose if a practicable alternative exists for the relocation of the moose to suitable habitat where the moose will not be a nuisance. [THE COMMISSIONER SHALL SEEK TO RELOCATE NUISANCE MOOSE AT THE LEAST COST TO THE STATE.] The commissioner may authorize one or more private individuals or groups to relocate nuisance moose to suitable habitat designated by the department if, upon review and evaluation of a written application and proposal, the commissioner finds that the individual or group is qualified to relocate nuisance moose without undue danger to the public, themselves, or the moose.

Before relocating ^{with} / nuisance moose, an individual or group shall provide financial assurances acceptable to the commissioner that will cover the state's reasonable, anticipated costs of the relocation. The individual or group shall reimburse the state's costs that arise from relocating / nuisance moose. A civil action to recover damages or costs that arise from relocating / nuisance moose may not be brought against the state, its political subdivisions, officers, or employees. In this section, "nuisance moose" means / moose designated by the department in an area of concentrated human population that poses a significant risk to the health, safety, or economic well-being of persons in the area.

CS for SB 329 (RES)

Senate Resources Changes

Page 1, line 4 replaced the word commissioner with department

Page 1, line 8 added new language ... suitable habitat designated by the department.....

Page 1, line 10 added new language without undue danger

Page 1, lines 11 – 15 & Page 2, lines 1 – 2 added new language Before relocating nuisance moose, an authorized individual or group shall provide financial assurances acceptable to the commissioner that will cover the state's reasonable anticipated costs of the relocation. The authorized individual or group shall reimburse the state for its costs that arise from relocating nuisance moose. A civil action to recover damages or costs that arise from relocating nuisance moose may not be brought against the state or a political subdivision, officer, or employee of the state.

Page 2, line 2 – 3 added new language ...moose designated by the department.....



Alaska State Legislature

Senator Con Bunde
Senate District P

Vice Chair: Senate Finance Committee
Chair: Senate Labor & Commerce Committee
Member: Legislative Budget & Audit Committee

Sponsor Statement

SB 329

“An Act relating to control of nuisance moose.”

Moose are a highly valued asset of the State of Alaska and to all Alaskans. Preventing the unnecessary loss of moose to vehicle accidents should be a priority of the State. Protecting the public safety and managing moose for sustained yield for all Alaskans are responsibilities of the Legislature.

Unfortunately, in the more urban areas of the state, their interactions with humans pose a significant risk to the health and safety of both moose and humans. Six hundred moose and two to three people are killed each year in moose/vehicle collisions. Each collision costs \$15,000 in substantial vehicle repair costs, costing Alaskans \$9 million each year, not counting loss of wages, increased insurance premiums, or medical costs.

Yet, in rural areas where moose are vital to the subsistence lifestyle, the lack of moose has negatively impacted many who live in rural villages.

SB 329 adds a new section to AS 16.05 in order to assure maximum possible translocation of nuisance moose from urban areas of the state to suitable rural areas.

- Instructs the Commissioner of the Department of Fish & Game to avoid destruction of nuisance moose if a practicable alternative exists for the relocation of the moose to suitable habitat.
- Instructs the commissioner to relocate nuisance moose at the least cost to the State of Alaska.
- Allows the commissioner to authorize one or more private individuals or groups to relocate nuisance moose to suitable habitat under certain circumstances.

SB 329 is supported by the Alaska Moose Federation, the Alaska Board of Game, the Anchorage Police Department, the Anchorage School District, the City of Wasilla, and the Central Kuskokwim Fish and Game Advisory Committee, to name just a few.

I respectfully request your support.

Bill Number: SB 329
Short Title: "An Act relating to control of nuisance moose"
Sponsor: Senator Con Bunde
Current Version: SB 329
Contact: Karen McCarthy, Senator Con Bunde's Office

Summary:

- Instructs the Commissioner of the Department of Fish and Game to avoid destruction of nuisance moose if the moose can be relocated to a suitable rural habitat.
- Instructs the commissioner to relocate nuisance moose at the least cost to the State of Alaska. (*The intention is that relocation will cost the state nothing, as groups who would move the moose would do so with private funding.*)
- Allows the commissioner to authorize one or more private individuals or groups to relocate nuisance moose to suitable habitat if the commissioner finds that the individual or group is qualified to relocate the moose without (undue) danger to the public, themselves, or the moose.

Benefits:

- Removes nuisance moose from urban areas where their interactions with humans pose a significant risk to the health and safety of both moose and humans.
- Relocates moose to rural areas where the lack of moose has negatively impacted residents.

Background

- 600 moose and two to three people are killed each year in moose/vehicle collisions. Each collision costs \$15,000 in substantial vehicle repair costs, costing Alaskans \$9 million each year, not counting loss of wages, increased insurance premiums, or medical costs.
- "'Nuisance moose' means a moose located in an area of concentrated human population that poses a significant risk to the health, safety, or economic well-being of persons in the area."
- SB 329 is supported by, among others:
 - The Alaska Moose Federation
 - The Alaska Board of Game
 - Municipality of Anchorage
 - Anchorage Police Department
 - Anchorage School District
 - City of Wasilla
 - Central Kuskokwim Fish and Game Advisory Committee
 - Alaska Village Initiatives
 - Ninilchik Traditional Council

State of Alaska
 Department of Public Safety
 Moose-related Case Activity
 FY 2002 - FY 2003

Motor Vehicle Accident / Moose-Related Case Activity				
Description	Code	FY02	FY03	Notes:
Fatal MVA Involving Moose	9501	2	1	MVA = Motor Vehicle Accident
MVA with Injuries Involving Moose	9503	60	51	
MVA with Injuries Involving Moose (Comm Veh)	9503V	0	1	Commercial Vehicle
MVA-Damage to Vehicle Only with Moose	9505	731	651	
MVA-Damage Only Comm. Vehicle with Moose	9505V	21	11	Commercial Vehicle
MVA-with Department Vehicle with Moose	9512	2	4	
Vehicle in Ditch/Tfc Hazards Due to Moose	9576/9570	21	10	
		837	729	Total

Other People / Moose-Related Case Activity				
Description	Code	FY02	FY03	Notes:
Misc. Calls Ref. Moose	8027	48	27	
Moose Attacking Humans Complaints	8710	9	8	
Moose Nuisance Complaints	8712	74	59	
Calls Related to Defense of Life and Property	8721	10	6	
Complaints Concerning Dogs Harrassing Moose	8762	45	20	
Complaints of Illegal Feeding of Moose	8766	17	5	
Suspicious Circumstances Concerning Moose	9549	15	21	
Assist to Other Agencies Concerning Moose	9605	17	24	
Misc.Moose Related Offenses/Complaints	9610	100	60	
		335	230	Total

The Above Data does not include the Municipality of Anchorage

Numbers of moose donated to charities as result of motor vehicle accidents or other similar circumstances. These numbers are *September 1, 2003 to present.*

Municipality of Anchorage	112
Mat-Su Valley, Talkeetna areas	307
Soldotna/Keani Area	194
	706 Total

Alaska State Legislature

DURING SESSION
STATE CAPITOL
JUNEAU, AK 99801-1182
(907) 465-4843 (800) 892-4843
FAX: (907) 465-3871

WEB SITE
www.akrepublicans.org/Bunde

DURING INTERIM
716 W. FOURTH AVE.
ANCHORAGE, AK 99501-2133
(907) 269-0181
FAX: (907)269-0184

E-MAIL
Senator.Con.Bunde@legis.state.ak.us

SENATOR CON BUNDE

District P

VIC E-CHAIR: SENATE FINANCE COMMITTEE
CHAIR: SENATE LABOR & COMMERCE COMMITTEE
MEMBER: LEGISLATIVE BUDGET & AUDIT COMMITTEE

MEMORANDUM

DATE: March 12, 2004

TO: Senator Scott Ogan
Chair, Senate Resources Committee

FROM: Senator Con Bunde *CBunde*

RE: Hearing Request for SB 329

I respectfully request that you schedule a hearing for SB 329, "Nuisance Moose" as soon as practically possible.

I have enclosed the following documents:

- SB 329
- Sponsor Statement
- Information about the Alaska Moose Federation
- Letters of Support
- Request to Legal for a minor amendment

Mr. Gary Olson of the Alaska Moose Federation will arrange to be in Juneau to testify on the bill. Mr. Bud Burris would like to be able to testify via teleconference from the Fairbanks LIO about technical aspects related to moose relocation. I will provide you with a full list of witnesses who will want to testify in person and via teleconference as soon as possible.

If you have any questions or concerns, please do not hesitate to call me or my aide, Karen McCarthy, at 4843.

Thank you.



Post Office Box 231028, Anchorage, Alaska 99523 (907) 33-MOOSE

MISSION STATEMENT: Believing in the value of healthy moose populations for all Alaskans, The Alaska Moose Federation will be the leader in the effort to both initiate and maintain the quantity and quality of Alaska's moose population.

Advisory Board

Senator Ted Stevens
Senator Lisa Murkowski
Congressman Don Young
Governor Frank Murkowski
Lt. Governor Loren Leman
Senator Gene Theriault
Senator Ben Stevens
Senator Con Bunde
Senator Ralph Seekins
Senator John Cowderly
Senator Lyman Hoffman
Senator Lyda Green
Senator Scott Ogan
Senator Gary Wilken
Senator Thomas Wagoner
Senator Fred Dyson
Representative Pete Kott
Representative John Coghill Jr.
Representative Mary Kapsner
Representative Lesil McGuire
Representative Carl Morgan
Representative Nancy Dahlstrom
Wasilla Mayor Dianne Keller
Denali Borough Mayor
David Talerico
Rick Rydell—KENI Radio
Talk Show Host
Bill Collins—Range Scientist
Bud Burris—Biologist
Sterling Eide—Biologist

March 14, 2004

3/17

The Alaska Moose Federation Conservation Fund, Inc. Advisory Board Members

Dear Advisory Board Members;

Anchorage is very close to surviving its 2nd highest record snowfall winter. Our previous mild winters have spoiled a number of us who thought we were residents of a new banana belt but this winter has shown how not only Alaskans but also moose must cope with high snow levels in every day life. A major development The Alaska Moose Federation is close to accomplishing is its effort to provide a tool to the state of Alaska in the form of Senate Bill #329 that will be assigned to committees this week in Juneau. The bill is attached for your review. This bill allows the problem of ever-growing urban moose populations to be dealt with pro-actively by removing 'nuisance' urban moose from where they are a liability to rural Alaska where they will be an asset. Moose transplants of yesteryear were a common place with moving moose to the Copper River Delta, Berner' Bay and to other areas of Alaska. Major transplants have also occurred throughout areas of the 'lower 48' to re-establish herds in the states of Utah, Colorado and Michigan.

Please keep in mind that we are neither proposing something cavalier nor are we proposing unfunded mandates with putting the burden for these programs on the state that already is seeing major budget constraints. The primary biologist who is overseeing our efforts is the former state biologist who oversaw the caribou transplant to the Kenai Peninsula, muskox to the north slope of Alaska, bison, moose, sheep, etc. back when transplanting was the norm for the Department of Fish & Game. Our major cities in moose country are becoming incubators that must be dealt with. Being reactive to the negative aspects of growing moose populations is no longer acceptable.

We hope you enjoy the attached newsletter and also some detailed support for our senate bill. Thank you again for being on our Advisory Board. Many who have viewed our letterhead are enthused by such a substantial group of Alaskans coming together for the good of our moose and our state. I hope we are meeting your expectations as a non-profit. We look forward to your ideas and input of how we may better perform the mission of healthy moose statewide.

Sincerely,

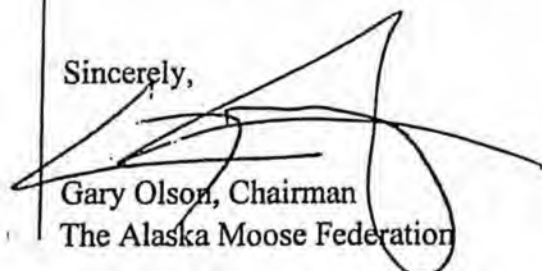

Gary Olson, Chairman
The Alaska Moose Federation



P.O. Box 231028, Anchorage, Alaska 99523 (907) 33-MOOSE

Chief Editor: Larry Kaniut Volume 1, Issue 3

"Let's Grow Some Moose!"

MISSION STATEMENT: Believing in the value of healthy moose populations for all Alaskans, the Alaska Moose Federation will be the leader in the effort to both initiate and maintain the quantity and quality of Alaska's moose population.

"Sportsman's Warehouse Believes in Alaska!"

On February 28, 2004 Sportsman's Warehouse held its grand opening of the new Anchorage store. This is store #21 in a nationwide chain. Attendees included their Chairman & CEO Stuart Utgaard, General Manager Patrick Nolde, Senator Lisa Murkowski, Governor Jay Hammond, AMF Cordova Club members Tom Plooy, Warren Olson and Dr. Lou Maier, AMF Chairman Gary Olson, AMF Directors John Floyd and Al Smay along with approximately 300 others welcoming Sportsman's Warehouse to Alaska.

This organization has known of The Alaska Moose Federation since January of 2004 yet only it took an enormous step in supporting our efforts. During the opening ceremonies, Stuart Utgaard, Sportsman's Warehouse's CEO, presented AMF's Chairman Gary Olson with a check for \$5,000.00 towards our efforts of rebuilding Alaska's moose. Chairman Olson thanked them and spoke to the significance of this pro-active organization.

"The Alaska Moose Federation

is only 15 months old but has succeeded in major foundation building in that time. Sportsman's Warehouse is also new to Alaska yet sees the importance of this organization enough to make a substantial donation to this just cause," said Chairman Olson to the assembled crowd.

The Alaska Moose Federation welcomes the Sportsman's Warehouse to Alaska and looks forward to a long relationship with this organization. Thank you again for the donation.

Inside this issue:

Sportsman's Warehouse Believes in Alaska!	1
Governor Murkowski joins the Advisory Board	1
Senator Bunde's Senate Bill #329 in Juneau.	2
Senator Murkowski helps moose & Alaskans.	2

Specific Programs:

- Continual education to all Alaskans of the benefit of healthy moose populations
- Road and railroad corridor protection.
- Habitat enhancement using machines and controlled burns.
- Cow and calf protection.
- Moose trans-planting from urban to rural Alaska.



CEO Stuart Utgaard

Senator Lisa Murkowski

Governor Jay Hammond

Governor Murkowski joins the Advisory Board!

On January 21, 2004, The Alaska Moose Federation received the following acceptance letter to our request for Governor Frank Murkowski to be involved with our efforts. We received the following response:

Dear Mr. Olson, Thank you for the invitation to become a member of your Advisory Board. I gladly accept the offer and look forward to being involved with The Alaska Moose Federation. With the environmental concerns and attacks on how Alaska manages its resources, it is good to see Alaskans coming together to preserve healthy moose populations. Again thank you for inviting me to become involved. Sincerely yours, Governor Frank Murkowski.

It sounds like our Governor is ready to lead our state into a new era of active moose management.

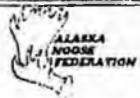



Senator Con Bunde Sponsors Senate Bill #329 in Juneau.

On February 13, 2004, Senator Con Bunde, at our request, introduced Senate Bill No. 329 in Juneau. The Senate bill reads as follows:

“An Act relating to control of nuisance moose.”

BE IT ENACTED BY THE LEGISLATURE OF THE STATE OF ALASKA:

- **Section 1.** AS 16.05 is amended by adding a new section to read:

Section 16.05.052. Nuisance Moose. The commissioner shall avoid destruction of nuisance moose if a practicable alternative exists for the relation of the moose to suitable habitat where the moose will not be a nuisance. The commissioner shall seek to relocate nuisance moose at the least cost to the state. The commissioner may authorize one or more private individuals or groups to relocate nuisance moose to suitable habitat if, upon review and evaluation of a written application and proposal, the commissioner finds that the individual or group is qualified to relocate nuisance moose without danger to the public, themselves, or the moose. In this section, “nuisance moose” means a moose located in an area of concentrated human population that poses a significant risk to the health, safety, or economic well-being of persons in the area.

This bill would allow an organization like the AMF to transplant possibly up to 250 moose annually out of the Anchorage Bowl to begin to gain control of this ever growing moose population. The key is to keep our city moose healthy. Moose are definitely a unique aspect to Alaska’s cities whose residents and visitors look forward to the occasional sight of a moose interacting with us.

The problem is that the populations in cities in moose country throughout the state are growing thus putting more moose on our school grounds, roads, trails and in neighborhoods at an alarming rate. Some schools in Anchorage have a near daily occurrence of ‘pushing’ moose off the playgrounds. We must have the tools to transplant moose to address these ever growing populations because inactivity continues to force us to experience negative aspects of life with moose.

Currently the #1 moose/vehicle collision location in the entire state is near the intersection of Tudor and Bragraw in Anchorage. Please support this legislation to help not only our moose but also us. Playing ‘moose roulette’ every time we walk, jog or drive through our cities is no longer acceptable. Do you think this is a new concept? How did moose get to the Copper River Delta outside of Cordova?

Senator Murkowski is ready to act to help reduce moose/vehicle accidents.

The following are some quotes from Senator Murkowski and her interest in helping with our programs:

“I read with great interest the Sunday Anchorage Daily News story (February 22, 2004) about the Federation’s work related to moose and traffic accidents, the lack of moose in many parts of the state and the need to address solutions for both subsistence hunters and Alaskan drivers.

As a member of the Senate’s Environment and Public Works Committee, which has jurisdiction over highway programs, I am particularly interested in learning more about your suggestions for road fencing and over- or under-passes to allow moose to safely cross the road. Consideration of wildlife crossings was an integral part of the highway authorization bill that recently passed the Senate. I would also welcome further information on your idea of transplanting moose to areas of Alaska where the populations are declining. I would be interested in seeing data from Fish & Wildlife experts on this suggested approach. Recalling that moose were transplanted from South central Alaska to the Copper River Delta and to Southeast Alaska in the 1950’s, I know this is a possibility that needs to be fully examined.—Senator Lisa Murkowski

“It’s Time To Help Our Moose!”

www.growmoremoose.org

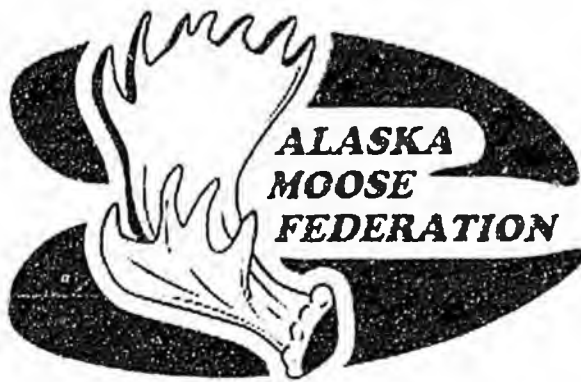

P.O. Box 231028, Anchorage, Alaska 99523 (907) 33-MOOSE

Chief Editor: Larry Kaniut Volume 1, Issue 2

"Let's Grow Some Moose!"

MISSION STATEMENT: Believing in the value of healthy moose populations for all Alaskans, the Alaska Moose Federation will be the leader in the effort to both initiate and maintain the quantity and quality of Alaska's moose population.

"A major endorsement for our efforts comes from rural Alaska!"

On October 7, 2003, Gary Olson, Chairman of The Alaska Moose Federation attended the Alaska Village Council Presidents (AVCP) 39th Annual Convention with fellow AMF Director Greg Roczicka in Bethel, Alaska. Greg, being a resident of Bethel and also very active in rural issues, was instrumental in making sure this new organization was given the proper attention at the convention.

The AVCP is a non-profit organization committed to programs that enhance rural culture and traditions throughout the Yukon-Kuskokwim Delta. This is a very important forum for The Alaska Moose Federation. The potential of securing support from one of Alaska's largest rural organizations is vital to our success.

The decision was made to make a presentation before AVCP's

Board of Directors, the 56 village delegates and the convention as a whole.

Following the presentation Gary Olson returned to Anchorage to continue working on the Banquet preparations while Greg remained to further request support for the AMF.

On October 9th, a proposed resolution of support was brought up before the AVCP Board for consideration. The resolution was passed unanimously. The only comment offered was from the Chair of the Resolutions Committee to the effect of "This one's a no-brainer, as simple as the proverbial Mom and Apple Pie for us, short and to the point. Anybody here going to vote against moose?" In addition, a request for the Alaska Federation of Natives was also passed for the

AFN to adopt a similar support resolution for the Alaska Moose Federation.

The Resolved section of AVCP's resolution is as follows:

NOW THEREFORE BE IT RESOLVED THAT the Association of Village Council Presidents supports and endorses the purpose of the Alaska Moose Federation in their efforts to rebuild and enhance moose populations across the state.

BE IT FURTHER RESOLVED THAT this resolution should be forwarded to the next convention of the Alaska Federation of Natives requesting their support of these efforts as well.

The Alaska Moose Federation is now truly a statewide organization in its efforts and support.

Inside this issue:

A major endorsement from rural Alaska.	1
Here comes the Junior Moose Troop!	1
Habitat program gets a major boost from Wilder.	2
The Advisory Board is continuing to grow.	2

Specific Programs:

- Continual education to all Alaskans of the benefit of healthy moose populations.
- Road and railroad corridor protection.
- Habitat enhancement using machines and controlled burns.
- Cow and calf protection.
- Moose trans-planting from urban to rural Alaska.



Attention all kids! Here comes the Junior Moose Troop!



The Alaska Moose Federation is creating a "kids only" portion of the organization called the Junior Moose Troop. Our goal is to educate our future generations to be better stewards of moose than we are. Our children interact with moose as much (if not more in some cases) than we do. The Chairman cannot even remember how many times he had run-ins with moose while growing up in Anchorage.

Details and funding for this new membership are still being worked out. Our younger members can expect Alaska moose coloring and activity books, field trips and classroom visits by biologists and AMF personnel. Pre-teen and older members will be participating in Alaska Moose Federation summer camps, hands-on activities including habitat enhancement, photography outings, fishing trips, etc.

Some teachers around the state are already doing this in one form or another dealing specifically with moose. We want to expand some of these successful programs that will work mostly within existing school programs utilizing some of their teachers, concerned citizens, local Department of Fish & Game, Division of Forestry and Public Safety personnel in both urban and rural Alaska.

Teaching our youth how to live with and be good stewards of our moose is very important. Alaska's moose and our kids deserve it!

Habitat Program gets a major boost from Wilder Construction!

In the world of moose management, substantial amounts of research have been performed in both Alaska and around the world to determine habitat manipulation procedures that result in healthier moose populations.

We are on the tail-end of decades of hands-off management in Alaska where not only timber development was at minimums but also a very active fire suppression program fought most forest fires across the state. Forest fires are nature's way of regenerating forests which are necessary for healthy moose. In an area where the willow, aspen and birch have grown out of reach of the existing moose population, the result is the continual decline of moose herds.

Alaska now has a resource developing state administration that is likely considering timber development. This is good for our moose if it is done correctly. It is now time to put all of the moose research that the state has to use. It has been cal-

culated in the international moose journal *Alces* (Volume 34, Number 2, 1998 Collins and Schwartz) that a forest with good regeneration has 15.3 times more browse than a forest with poor regeneration.

Some concepts to remember that should go hand in hand with timber development are as follows:

#1 Post-logging site preparation and reforestation should always be included in timber development.

#2 Certain areas should be left uncut inside timber harvesting operations that will provide cover and protection for moose.

#3 Scarification of the remaining overburden should be performed within 1 year of the logging activity to encourage hardwood growth over grass production.

#4 Mature willow trees should remain in timber harvest areas to encourage the growth of future browse for moose.

These are just a few of the procedures that must take place for successful habitat for moose. Not only would these projects provide food for our suffering moose herds but it could also be done in such a fashion to remove many moose from our transportation corridors.

How can the state even begin to work on this level with our current budget cutting?

The Alaska Moose Federation approached Mr. Bill Hopper with Wilder Construction on the concept of his company donating operational use of their heavy equipment for habitat projects where their equipment winters. They realize the positive outcomes of our programs and agreed to be involved.

The Alaska Moose Federation again thanks Wilder Construction for their substantial part in helping to rebuild Alaska's moose populations.

The Alaska Moose Federation adds Senator Ted Stevens to its Advisory Board.

On July 5, 2003, The Alaska Moose Federation sent a letter to Washington D.C. requesting the Honorable Ted Stevens to be on the Advisory Board. We received the following response:

Thank you for your offer of a position on the Advisory Board of the Alaska Moose Federation. I appreciate the efforts you are undertaking in rebuilding and maintaining stable moose populations and I look forward to participating in your efforts. An issue such as this one is important to the state as a whole and it seems that you have been conscious of this in your efforts to solicit state-wide opinion. I congratulate you for this and you may include my name in your letterhead. With best wishes, TED STEVENS

"It's Time To Help Our Moose!"

www.growmoremoose.org



P.O. Box 231028, Anchorage, Alaska 99523 (907) 33-MOOSE

Chief Editor: Larry Kaniut Volume 1, Issue 1

"Let's Grow Some Moose!"

MISSION STATEMENT: Believing in the value of healthy moose populations for all Alaskans, the Alaska Moose Federation will be the leader in the effort to both initiate and maintain the quantity and quality of Alaska's moose population.

"What does Alaska need another outdoor outfit for?"

Inside this issue:

Why does Alaska need a new outdoor outfit?

Alaska Moose Federation's trip to Juneau.

Alaska Railroad Cantwell Fence Plan.

The Successful Cordova Moose Transplant.

Specific Programs:

- Continual education to all Alaskans of the benefit of healthy moose populations.
- Road and railroad protection.
- Habitat enhancement using machines and controlled burns.
- Cow and calf protection program.
- Moose trans-planting.

1 This is a good question to ask. My name is Gary Olson and I am the Chairman and the founder of the Alaska Moose Federation.

1 Alaska already has organizations for wild sheep, elk, ducks, grouse, fish, bears, etc. Are we missing anything? Alaska's moose have been taken for granted long enough.

2 Most Alaskans think there are more moose than ever. The only problem is that they are in our cities. Our neighborhoods have become incubators for our long eared friends. Though most of us are used to moose in the driveway and have adjusted our lives, over 600 moose are killed in our cities by vehicles annually. At an average of \$15,000.00 per accident (per AKDOT), that is an increasing annual loss of over \$9,000,000.00 to Alaskans in vehicle damage alone.

Take into account that each cow moose is worth an average of 30 moose based her population potential. With a calculation of the moose that are hit (50% cows, 10% bulls and 40% calves), we lose just over 12,000 moose on our city roads each year!

Now imagine the AMF working with the Department of Fish & Game taking a trailer full of our city moose and trans-locating them to Unit 13. How about a 20' connex special made container loaded with cows and calves moved out to McGrath. This would go a long way towards healing the 'urban-rural' divide that others have created to pit Alaskans apart.

This is why we have begun to work with the our new Admini-



Cow moose with a newborn calf. Spring time is the most dangerous time for Alaska's calves.

stration, Legislators, Departments of Fish & Game, Natural Resources, Transportation and Public Safety. Another necessity for the AMF is that it will conduct itself with salaried staff. This is a lesson that we have learned from outside special interests that spend millions of dollars to influence Alaska.



The Alaska Moose Federation Goes To Juneau!



Eberhard Brunner, John Floyd and Gary Olson flew to Juneau on March 31 for a 3-day "get to know you" with our new Administration and Legislature.

Our message was simple: "The AMF is neither a hunting nor an anti-hunting outfit. It is neither a subsistence priority nor a anti-subsistence priority organization. We are solely committed to healthy moose populations statewide."

We also detailed to the Legislators the benefits of healthy moose population. Our tourists will have moose to see, Alaskans (both rural and urban) will once again have their Alaskan lifestyles back and our predators will have something to eat. The current state of extremely low, if not zero, recruitment of calves to mature moose is as unacceptable as the wolf pups being eaten by the adult wolves for lack of food.

The AMF detailed how we run our railroad through some of the best habitat in the state, our roads run through major moose migratory routes and we do a good job putting most fires out as soon as they start that would otherwise make moose food. It is time for Alaska to be better stewards of our moose and you know what, nearly all Legislators from all corners of Alaska agreed 100%.



The Alaska Railroad and the Alaska Moose Federation Working Together!

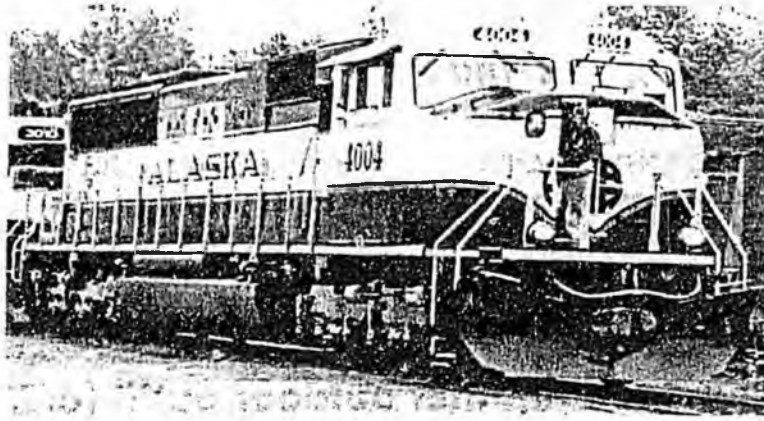

We have targeted a Railroad corridor in the Cantwell area that is the perfect candidate for our new form of proper moose stewardship.

The Cantwell Alaska Railroad Corridor Project is located adjacent to the confluence of the Jack and the Nenana Rivers. This particular area is ideal for wintering moose habitat that draws moose from many areas in the vicinity. Primary land Owners in the vicinity include the State of Alaska, AHTNA Native

Corporation lands, Denali National Park and other Federal Lands as well. With the moose being drawn to the food every winter, this puts large numbers of moose in jeopardy from collisions with the Railroad. Approximately 8 miles of track run through the middle of this ideal food source that results in the loss of over 100 moose on heavy snow years. This is where the Alaska Moose Federation comes in.

We, at the AMF, are currently working with the Denali Citizens Fish and Game Advisory Committee, Alaska Railroad, AHTNA Village Council, Denali Borough, Senator Ted Stevens and now the Alaska Legislator and the Alaska State Administration to change this. We are proposing a fenced corridor with underground/overpass crossing areas as performed on the Glenn Highway between Muldoon and Hiland Road. Other areas in the world use fencing and underground causeways extensively to significantly reduce the



Overpass proven highly successful for moose crossing over railroads or roads.

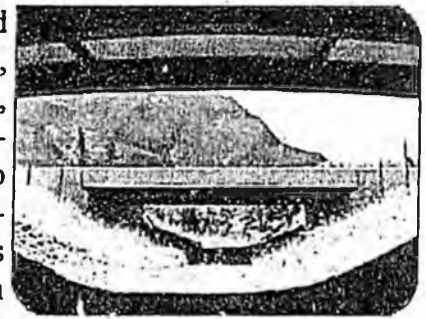

Underpass proven highly successful for moose crossing beneath railroads or roads

loss of their animals. We are not proposing unique or risky concepts, just implementing successful programs as seen elsewhere. Still think this might be another casual outfit?

Is Transplanting Moose new to Alaska? Not at all! How did Moose get in Cordova?

The first moose transplant in Alaska was conducted near Cordova on the Copper River Delta between 1949 through 1958. During that period, calves were received from well-meaning Alaskans throughout South-Central Alaska believing that the calves had been abandoned by their mothers. During that period,

approximately 50 calves were collected with the largest single transplant taking place of 5 moose in 1951.

By 1954, considerable evidence had been gathered that observed successful wintering and breeding of this new moose herd to the Copper River Delta. A limited harvest occurred in 1960.

Twenty-five bulls were harvested that year. Hunting again resumed in 1962 with another 25 bulls harvested. The herd has been completely self-sustaining now for decades. This is the last era the State of Alaska actively pursued the organized transplant of moose until now.

"It's Time To Help Our Moose!"

www.growmoremoose.com



P.O. Box 231028, Anchorage, Alaska 99523 (907) 33-MOOSE

PROGRAM PAGE FOR THE ALASKA MOOSE FEDERATION

Advisory Board

Senator Ted Stevens
Senator Lisa Murkowski
Congressman Don Young
Lt. Governor Loren Leman
Senator Gene Theriault
Senator Ben Stevens
Senator Con Bunde
Senator John Cowdery
Senator Ralph Seckins
Senator Lyman Hoffman
Senator Lyda Green
Senator Scott Ogan
Senator Gary Wilken
Senator Robin Taylor
Senator Thomas Wagoner
Representative Pete Kott
Representative John Coghill Jr.
Representative Mary Kapsner
Representative Lesil McGuire
Representative Carl Morgan
Denali Borough Mayor
David Talerico
Mr. Rick Rydell—KENI Radio
Talk Show Host
Mr. Bud Burris—Biologist
Mr. Sterling Eide—Biologist

MISSION STATEMENT:

Believing in the value of healthy moose populations for all Alaskans, the Alaska Moose Federation will be the leader in the effort to both initiate and maintain the quantity and quality of Alaska's moose population.

- Program #1** Continual education to all Alaskans of the benefit of healthy moose populations. The Alaska Moose Federation is heading towards the schools in a big way in both rural and urban Alaska. We have been approached by people, including school teachers that are ready to make our next generation better stewards of our moose. We also plan to work with the Scouts and other youth organizations as well. Funds raised for this program will purchase items such as "kids only" membership into the Junior Moose Troop, magazines, T-shirts, moose coloring books, patches, moose pencils, stickers, etc.
- Program #2** Road and Railroad Protection. The Alaska Moose Federation is already well under way on this particular program. The Alaska Railroad has been extremely receptive with our intent to assist in placing direction fencing with underpasses/overpasses for the moose to cross the railroad. Alaska's Department of Transportation has also been equally receptive to the necessity for this on some of our worst moose accident roads. Funds raised for this program will purchase fencing materials, roadway moose signs, necessary costs associated with staff oversight, etc.
- Program #3** Habitat enhancement using machines and controlled burns. We have met with our State's Department of Natural Resources who is very enthused about the concept of working with The Alaska Moose Federation. Substantial work lies ahead on this project. In order to make sure the ecosystem is in balance, our Alaskan moose must have proper habitat for food and protection. Funds raised for this program will pay for heavy equipment, maintenance costs, fuel, operators and costs associated with our proposed habitat biologist.
- Program #4** Cow and calf protection program. As seen recently with the Chisana caribou herd while summering in Canada, the Canadian government went and fenced a large area while local elementary school children collected food for the caribou. Canada knows how important caribou are and is helping the caribou calves survive. With an estimated 56% of Alaska's moose on the decline and 10% or less recruitment of moose from calves to adults in many areas of the State, something must be done in Alaska to turn this around. If we can help our administration take similar steps protecting our moose calves, we are on the road to making moose important again.
- Program #5** Moose trans-planting. This is a program designed to reduce the dangerous surplus of moose in urban Alaska and trans-plant them to rural Alaska where there is a dangerous shortage. The commencement of this program lies with our Administration. With our recent mild winters encouraging high calf survival in our cities, big problems are looming for our city moose if nothing is done.

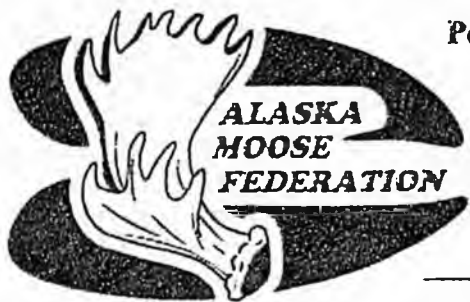

Post Office Box 231028, Anchorage, Alaska 99523 (907) 33-MOOSE

MISSION STATEMENT: Believing in the value of healthy moose populations for all Alaskans, The Alaska Moose Federation will be the leader in the effort to both initiate and maintain the quantity and quality of Alaska's moose population.

Advisary Board

- Senator Ted Stevens
- Senator Lisa Murkowski
- Congressman Don Young
- Governor Frank Murkowski
- Lt. Governor Loren Leman
- Senator Gene Therriault
- Senator Ben Stevens
- Senator Con Bunde
- Senator Ralph Seekins
- Senator John Cowdery
- Senator Lyman Hoffman
- Senator Lyda Green
- Senator Scott Ogan
- Senator Gary Wilken
- Senator Thomas Wagoner
- Senator Fred Dyson
- Representative Pete Kott
- Representative John Coghill Jr.
- Representative Mary Kapsner
- Representative Lesil McGuire
- Representative Carl Morgan
- Representative Nancy Dahlstrom
- Wasilla Mayor Dianne Keller
- Denali Borough Mayor
David Talerico
- Rick Rydell—KENI Radio
Talk Show Host
- Bill Collins—Range Scientist
- Bud Burris—Biologist
- Sterling Eide—Biologist

March 8, 2004

Alaska Department of Law
Attn: Attorney General Renkes
P.O. Box 110300
Juneau, Alaska 99811

COPY

Dear General Renkes;

This letter is designed as a follow up to our hasty discussion outside of the Outdoor Council meeting in Fairbanks. I realize this administration as a whole's hectic schedule so your attendance was greatly appreciated. Attached are the first 3 letters of support for our Senate Bill #329.

First and foremost, this bill deals with the necessity for public safety not only on the schools and neighborhoods but also on our city roads due to ever increasing moose populations. Its secondary intent is to help the state address its efforts at increasing moose populations throughout Alaska. The Alaska Moose Federation is offering itself as a tool to the state to help with all of these topics.

I appreciate your concern for the state and its residents with your intent to seek the administration's position on this bill. Dave Dittman (who is also one of our directors) is speaking with the Governor this afternoon on this and other issues. I hope the administration agrees with taking a pro-active approach on this problem and supports Senate Bill #329.

In addition, could we also have the Department of Law provide a position letter not only on the intent of Senate Bill #329 to reduce the state's liability on the issue of increasing moose in our cities but also address our attempt to fix known moose/vehicle collision corridors on our highways as well. We are working with Senator Murkowski (see attached letter) to begin to address these known corridors with proven methods backed by science that will significantly reduce future accidents. This support from the Department of Law will assist our efforts of working with other state/federal agencies to become pro-active as well with our roadways.

If you have any questions regarding these requests or anything else, please call me at (907) 351-1335.

Sincerely,

Gary Olson, Chairman
The Alaska Moose Federation



Post Office Box 231028, Anchorage, Alaska 99523 (907) 33-MOOSE

MISSION STATEMENT: Believing in the value of healthy moose populations for all Alaskans, The Alaska Moose Federation will be the leader in the effort to both initiate and maintain the quantity and quality of Alaska's moose population.

Advisory Board

Senator Ted Stevens
Senator Lisa Murkowski
Congressman Don Young
Governor Frank Murkowski
Lt. Governor Loren Lemman
Senator Gene Therriault
Senator Ben Stevens
Senator Con Bunde
Senator Ralph Seekins
Senator John Cowdery
Senator Lyman Hoffman
Senator Lyda Green
Senator Scott Ogan
Senator Gary Wilken
Senator Thomas Wagoner
Senator Fred Dyson
Representative Pete Kott
Representative John Coghill Jr.
Representative Mary Kapsner
Representative Lesil McGuire
Representative Carl Morgan
Representative Nancy Dahlstrom
Denali Borough Mayor
David Talerico
Rick Rydell—KENI Radio
Talk Show Host
Bill Collins—Range Scientist
Bud Burris—Biologist
Sterling Eide—Biologist

February 16, 2004

Dear Senate Bill #329 Supporters;

Please review the following Senate Bill #329 that would allow an organization such as the Alaska Moose Federation to transplant a minimum of 250 moose annually out of the Anchorage Bowl to begin to gain control of this ever growing moose population. Moose are definitely a unique aspect to Alaska's cities whose residents and visitors look forward to the occasional sight of a moose interacting with us. The problem is that the populations in cities throughout the state are growing thus putting more moose on our school grounds, roads, trails and neighborhoods at an alarming rate. Some schools in Anchorage have a near daily occurrence of 'pushing' moose off the playgrounds. We must have the tools to transplant moose to address these ever growing populations because inactivity continues to force us to experience negative aspects of life with moose.

It is imperative that we gather as many letters of support for the following Senate Bill #329 as possible this week. Address for Juneau is Senator Bunde, State Capitol Room #506, Juneau, Alaska 99801. Please provide an additional copy to The Alaska Moose Federation, P.O. Box 231028, Anchorage, Alaska 99523. Typical points of discussion/support to build your letters for supporting the bill are as follows:

- #1 South central Alaska is currently experiencing its 2nd highest snow fall this winter. Moose are continually placed in harms way on our roads, school grounds
- #2 Moose are a highly valued asset to the State of Alaska, and are important to all Alaskans.
- #3 People from all over the state will benefit from this one bill. Public safety is paramount in the cities where the moose populations are at a dangerous surplus and the Alaskan lifestyle is paramount throughout rural Alaska where moose are very scarce. The ability to transplant moose to rural Alaska to help rebuild existing populations is crucial.
- #4 From 1996—2000, there was an average of 661 moose/vehicle collisions throughout Alaska. According to 1995 DOT study, vehicle damage averages \$15,000 per hit. Also per that study, we can expect 2 times the number of moose/vehicle hits due to a heavy snow year that will total 1,322 moose/vehicle hits this year. \$15,000 per hit x 1,322 hits = \$19,830,000 in vehicle cost alone. We can no longer to allow moose (and people) to deal with these problems any more.

- #5 According to AKDOT 1995 study, 50% of all moose hit on roads are cows, 40% are calves (half are cows) and the remaining 10% are bulls. Each cow lost means a large reduction in future moose populations. This is unacceptable. Move moose away from the roads into safe areas where habitat is ample.
- #6 Public safety is a basic responsibility of the legislature. Please pass this legislation that will help stem off the negative aspect of moose when they interact with people. The UAA professor that was stomped to death a number of years ago at UAA was avoidable. If organizations are allowed to move animals out of harms way, both the moose and people will benefit. Public safety must be a driving component of this legislation.
- #7 Alaska's Constitution, Article VII, mandates moose management by the sustained yield principle (primarily for human food, based on the notes of the Natural Resources Committee from the Alaska Constitutional Convention) for the benefit of all Alaskans. In rural Alaska, moose are primarily used for food for human sustenance. However, failure to manage for the sustained yield of moose in remote Alaska has led to acute moose shortages in and around many Alaskan villages. Meeting the needs for moose in these situations should be a priority of the legislation.
- #8 Currently Department of Fish & Game has the population of moose at 2400 in the Anchorage Bowl. This population is healthy and ever increasing. Neighborhoods, roads and schools are continuing to be built while the human population also grows. Cars are getting smaller and faster while moose are continually coming onto our roads in increasing numbers. Currently the #1 moose/vehicle location is at Tudor and Bragraw. These tools that will allow proper stewardship of moose in our cities is absolutely necessary. Please support this legislation to help not only our moose but our residents too.
- #9 Imagine the concept of using surplus 'urban' moose to help rebuild dangerously low 'rural' moose populations. The old argument that has prevailed with some in power to continually pit Alaskans against each other has not produced any moose for any of us. Managing for minimums does not benefit anyone let alone anything. This is the beginning of Alaska handling our own affairs and is a great tool to show the Lower 48 that we know what the problems are and we are going to take care of our own business. This is the beginning of the healing of the urban-rural divide.
- #10 The Alaska Moose Federation was founded upon the concept that moose (a natural resource owned by all Alaskans) are too valuable to all Alaskans to allow to be wasted on our roads and in the cities of Alaska. Oil is also a commonly owned natural resource that has justified major action in verifying its quantity and quality for all Alaskans. Unlike oil, our moose are a renewable resource that can (if managed correctly) be here for generations to come. The AMF was created when the Alyeska pipeline was shot and the state agencies responded immediately to that state of emergency. Senate Bill #329 will begin to give Alaska's moose the same worth as Alaska's oil. It is a tool that will allow organizations like the AMF begin to 'fix' our moose problems to return Alaska to its earlier reputation of the world's greatest moose.
- #11 Transplanting moose is nothing new to the State of Alaska. Moose were collected throughout south central Alaska and moved to the Copper River Delta near Cordova from 1949 to 1958. Moose were also sent near Juneau and to Kalgin Island. Moose have also been successfully transplanted in Utah, Colorado and Michigan to establish new populations. The Alaska Moose Federation is offering to raise all funds associated with these projects while under the oversight of the Alaska Department of Fish & Game.

Thank you for staying involved and let's grow some moose!

Gary Olson, Chairman
The Alaska Moose Federation

ALASKA MOOSE FEDERATION

Moose Facts to Get You Involved!

DID YOU KNOW #1

Sweden, the size of California, harvested over 170,000 moose last year. Alaska currently has around 150,000 moose total. Alaskans can manage better.

DID YOU KNOW #2

What about nature's way? We run our Railroad through some of the best habitat in the state, we push our roads through moose's migration routes and we put most fires out as soon as they start which is nature's way of creating moose food. We are all part of nature.

DID YOU KNOW #3

With 600+ moose hit by cars in our cities with each collision costing \$15,000.00, Alaskans annually pay \$9,000,000.00 and climbing. This does not take into account loss of wages, medical costs or even loss of human life. Alaskans must do better on our roads.

DID YOU KNOW #4

The 600 moose lost each year on our roads consist of 50% cows, 40% calves and 10% bulls. Since a cow is worth around 30 animals because of her population potential and half of the calves are cows, we really lose 12,780 moose on our roads alone. We need to do better!

DID YOU KNOW #5

Each year, about 650,000 moose, caribou and sheep babies are born in Alaska. Of this population, less than 3% will be harvested by human hunters. About 10% will die of natural causes while the remaining 87% (600,000 animals) will be killed by predators.

DID YOU KNOW #6

In Urit 13, once considered the bread basket of the state that consists of 23,000 square miles, the moose population reached a high in the fall of 1988 of 27,500 moose. In 2000, the fall population was 9,000 moose. It has been said that given these trends, there may likely be no moose in a majority of the unit in the near future.

DID YOU KNOW #7

The Alaska State Constitution mandates the State of Alaska to manage moose on sustained yield principle for the benefit of the resource and the people of the state. With our new State Administration, the Dept. of Fish & Game, Department of Natural Resources and the Alaska Moose Federation working together, we can take proactive roles of rebuilding our moose.

DID YOU KNOW #8

A moose, in order to stay healthy, must eat 40 pounds of browse daily.

DID YOU KNOW #9

Large bull moose are extremely vital to healthy moose populations. In the rut (annual mating season), large groups of cow moose (called harems) gather under the protection of ideally a large bull (greater than 50" spread). The cows all come into estrus simultaneously. Only large bulls can sire all the cows in their first cycle. If a younger bull is overseeing the harem, some of the cows will miss being impregnated until the next cycle that will cause the calves to drop a month late in the spring. Not only do these calves face much higher mortality rates because they have one month less to prepare for winter, but also the window of opportunity for predators to take these newborns is extended thus impacting the herd twice as hard. The Alaska Moose Federation will establish herds where large, dominant bulls are the norm and not the exception.

Alaska Moose Federation Moose Transplant Trailer

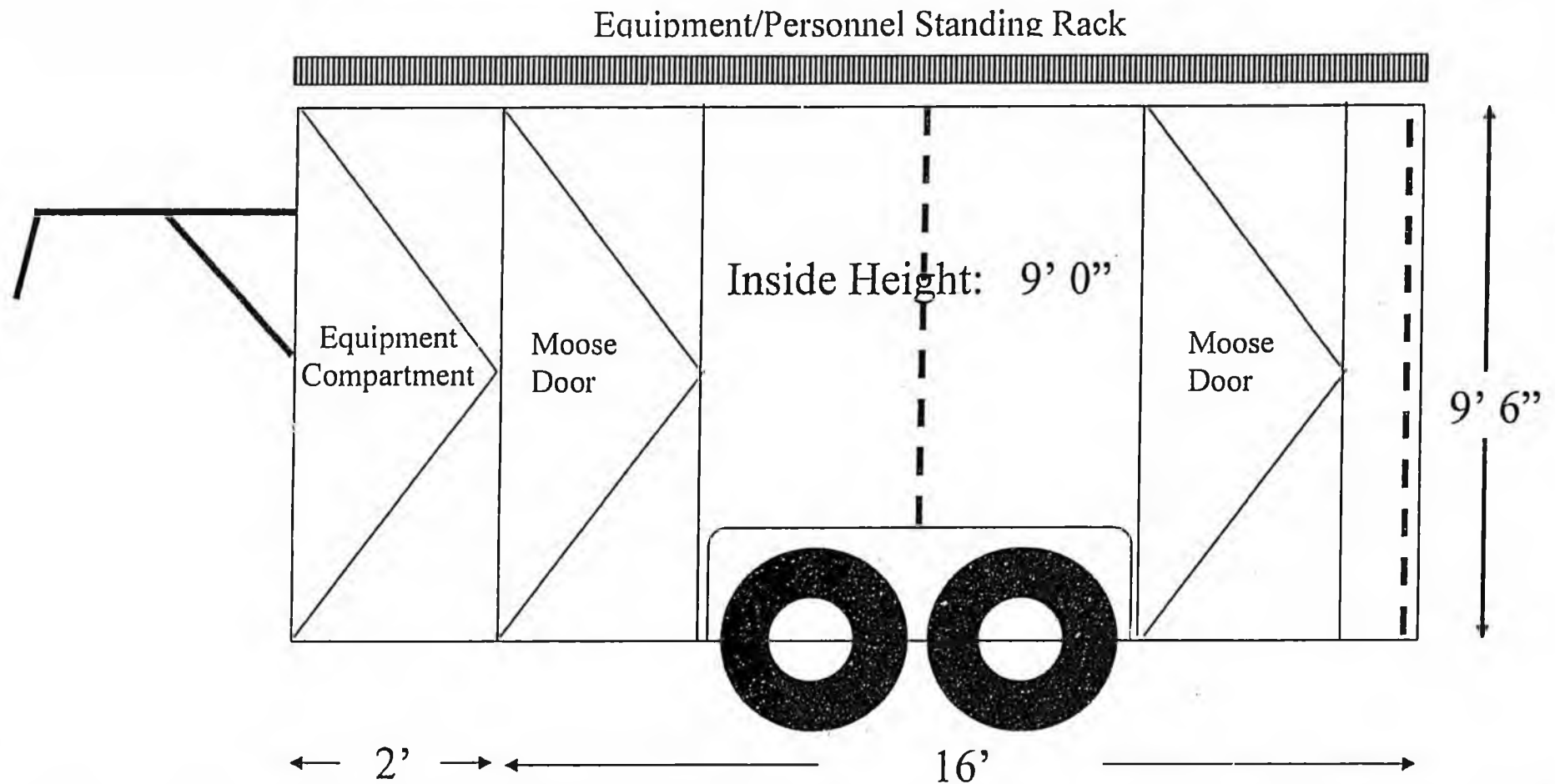

- Specifications:
- #1 8,000 GVW, Drop axles (trailer as low to the ground as possible), greaseless axles, soft suspension.
 - #2 9' 0" interior ceiling, as wide as possible.
 - #3 Aluminum construction included solid sides for minimal visible for moose to see out.
 - #4 Multiple ventilation units on roof, sides, etc.
 - #5 Interior lined with 5/8" plywood with multiple ventilation holes. Boards must be replaceable.
 - #6 2' wide equipment compartment accessible from both sides for equipment. Sealed/ lockable doors.
 - #7 Separating wall diving front from rear of trailer made of 1" tubing 6" OC for visible but no access.
 - #8 Multiple locations for movable winch mounts. See diagram on second page.

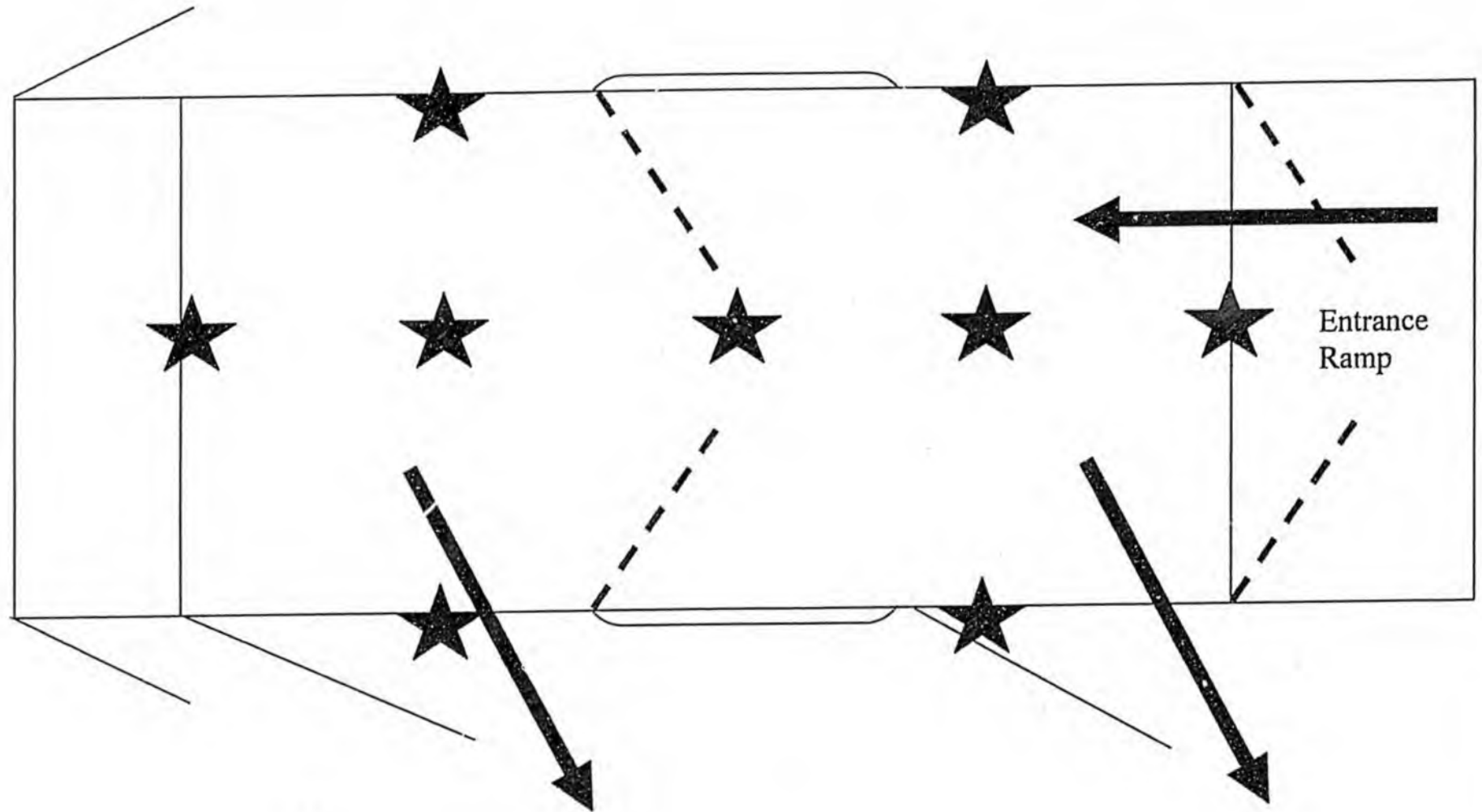

★ = Winch Mounts/ Snatch Block Locations

TED STEVENS, ALASKA, CHAIRMAN

THAD COCHRAN, MISSISSIPPI
ARLEN SPECTER, PENNSYLVANIA
PETER DOMENICI, NEW MEXICO
CHRISTOPHER S. BOND, MISSOURI
MITCH MCCONNELL, KENTUCKY
CONRAD BURNS, MONTANA
ROBERT C. BYRD, ALABAMA
LLOYD BREGG, NEW HAMPSHIRE
ROBERT F. BENNETT, UTAH
DENNY THORPE CAMPBELL, COLORADO
LARRY CRAIG, IDAHO
RAY BAILEY HUTCHISON, TEXAS
TOM CARROLL, IOWA
BILLY BROWN, KANSAS

ROBERT C. BYRD, WEST VIRGINIA
DANIEL K. INOUE, HAWAII
ERNEST F. HOLLINGS, SOUTH CAROLINA
PATRICK J. LEAHY, VERMONT
TOM HARKIN, IOWA
BARBARA A. MIKULSKI, MARYLAND
HARRY REID, NEVADA
HERB KOHL, WISCONSIN
PATTY MURRAY, WASHINGTON
BYRON L. DORGAN, NORTH DAKOTA
DIANNE FEINSTEIN, CALIFORNIA
RICHARD J. DURBIN, ILLINOIS
TIM JOHNSON, SOUTH DAKOTA
MARY L. LANDRIEU, LOUISIANA

United States Senate

COMMITTEE ON APPROPRIATIONS
WASHINGTON, DC 20510-6025
www.senate.gov/appropriations

JAMES W. MORHARD, STAFF DIRECTOR
TERRENCE E. SAUVAIN, MINORITY STAFF DIRECTOR

July 31, 2003

Gary Olson
Chairman
The Alaska Moose Federation
P.O. Box 231028
Anchorage, Alaska 99523

Dear Gary:

Thank you for your offer of a position on the Advisory Board of the Alaska Moose Federation. I appreciate the efforts you are undertaking in rebuilding and maintaining stable moose populations and I look forward to participating in your efforts. An issue such as this one is important to the state as a whole and it seems that you have been conscious of this in your efforts to solicit state-wide opinion. I congratulate you for this and you may include my name in your letterhead.

With best wishes,

Cordially,



TED STEVENS

LISA MURKOWSKI
ALASKA
MAJORITY DEPUTY WHIP

COMMITTEES:
ENERGY AND NATURAL RESOURCES
CHAIRMAN, SUBCOMMITTEE ON
WATER AND POWER
ENVIRONMENT AND PUBLIC WORKS
VETERANS' AFFAIRS
INDIAN AFFAIRS

United States Senate

WASHINGTON, DC 20510-0203
(202) 224-6665
(202) 224-5301 FAX

510 L STREET, SUITE 550
ANCHORAGE, AK 99501-1956
(907) 271-3735

101 12TH AVENUE, BOX 7
FAIRBANKS, AK 99701-6278
(907) 456-0233

P.O. Box 21647
JUNEAU, AK 99802-1647
(907) 586-7400

130 HLANDING BAY ROAD, SUITE 350
KENAI, AK 99611-7716
(907) 283-5808

540 WATER STREET, SUITE 101
KETCHIKAN, AK 99901-6378
(907) 225-6880

851 EAST WESTPOINT DRIVE, SUITE 307
WASILLA, AK 99654-7142
(907) 376-7665

February 23, 2004

Gary Olsen
Alaska Moose Federation
P.O. Box 231028
Anchorage, AK 99523

Dear Gary:

I read with great interest the Sunday Anchorage Daily News story about the Federation's work related to moose and traffic accidents, the lack of moose in many parts of the state and the need to address solutions for both subsistence hunters and Alaskan drivers. For subsistence hunters who rely on moose to meet their basic dietary needs the lack of moose in rural Alaska is devastating, while Alaska's sport hunters also feel the frustration with declining moose populations; for Alaskans who live on the road system the threat of hitting a moose at high speed is a life and death issue.

As a member of the Senate's Environment and Public Works Committee, which has jurisdiction over highway programs, I am particularly interested in learning more about your suggestions for road fencing and over- or under-passes to allow moose to safely cross the road. Consideration of wildlife crossings was an integral part of the highway authorization bill that recently passed the Senate. This is an especially important issue for parents whose children attend school in areas with high moose populations. Playing on the playground and waiting for school buses can be dangerous if moose are in the area.

I would also welcome further information on your idea of transplanting moose to areas of Alaska where the populations are declining. If practical, this idea could help both the overpopulation problem in urban areas while also addressing the subsistence and hunting problems in rural Alaska. I would be interested in seeing data from Fish and Wildlife experts on this suggested approach. Recalling that moose were transplanted from Southcentral Alaska to the Copper River Delta and to Southeast Alaska in the 1950's I know this is a possibility that needs to be fully examined.

Having lived in Alaska all my life I know the unique needs moose fill for many Alaskans and anything we can do to stabilize their populations can only help. I look forward to hearing more from you in the future.

Sincerely,

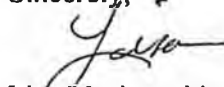

Lisa Murkowski
United States Senator

THE
FOLLOWING
DOCUMENT(S)
ARE
POOR
ORIGINAL
COPIES

STATE OF ALASKA

DEPARTMENT OF FISH AND GAME

BOARD OF GAME

FRANK H. MURKOWSKI, GOVERNOR

P.O. BOX 25526
JUNEAU, AK 99802-5526
PHONE: (907) 465-4110
FAX: (907) 465-6094

March 10, 2004

Senator Con Bunde
Alaska State Legislature
State Capitol (506)
Juneau, AK 99801-1182

Re: SB 329 Control of Nuisance Moose

Dear Senator Bunde,

The Alaska Board of Game wishes to note their unanimous support for the concept of relocating moose from urban areas where they are a nuisance to areas where moose are scarce.

We urge careful consideration of this concept and remain hopeful that it will be yet another tool for rebuilding ungulate populations. Further, we urge crafting of the legislation to allow adequate oversight by the Alaska Department of Fish and Game while minimizing cost to the department.

Thank you for considering this recommendation from the Board of Game

Respectfully yours,

Mike Fleagle,
Chairman, Alaska Board of Game

STATE OF ALASKA

Frank H Murkowski, Governor

Anchorage Fish & Game Advisory Committee

Bob Churchill, Chair
3415 Wentworth
Anchorage, AK 99508
Home: 279-8927
Work: 261-5421
FAX: 272-7675
Email: rock4@gci.net

Dear Senator Bunde:

The Anchorage Fish & Game Advisory Committee met on March 16, 2004 as normally scheduled. Mr. Gary Olson, Chairman of the Alaska Moose Federation, testified regarding Senate Bill 329, which you have sponsored. We reviewed the content of the bill and after a discussion voted in the majority to send you a letter in support of the objectives of the bill.

Our discussion focused, as did Mr. Olson's testimony, on safety related concerns generated primarily by incidents of vehicles colliding with moose. Mr. Olson clearly testified that the total cost of relocating these animals would be approximately \$1000.00 per animal and an upward estimate would be that 250 animals per year would require relocation.

If these incidents can be significantly reduced and the safety of people in the Anchorage area can be improved by relocating moose at a reasonable cost, we support effective efforts made to achieve this goal.

As you know other efforts have been made to achieve these same results, however they have failed due to a lack of implementation.

Sincerely,

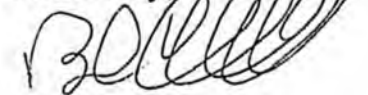

Bob Churchill

DENALI BOROUGH

P. O. Box 400 • Healy, Alaska 99743
Phone (907) 683-1330 • Fax (907) 683-1340
dbgovt@mlaonline.net
www.denaliborough.govoffice.com



David M. Talerico, Mayor

Senator Con Bunde
State Capitol Room # 506
Juneau, AK 99801

March 22, 2004

Dear Senator Bunde,

Please let this letter serve as support of Senate Bill 329, an act relating to control of nuisance moose.

I am pleased to hear that the Alaska Moose Federation has offered itself and its resources to help the State with moose population issues.

SB 329 speaks not only to public safety in and around schools, neighborhoods, trails and roads in an area of concentrated human populations, it also provides a dedicated effort in increasing moose populations throughout the State of Alaska in rural areas.

Moose sightings often leave the spectator in awe of this magnificent creature yet they pose a tremendous threat to drivers and outdoor enthusiasts who may unexpectedly encounter one. The medical and automobile insurance claims related to these incidents have dramatically increased premiums. Loss of life although unpleasant is a reality when moose interact with humans. All efforts must be made to avoid such interactions.

Therefore, I support Senate Bill 329, an act with minimal cost to the State and of great benefit to many Alaskans.

Sincerely,

David Talerico
Mayor

Cc: Senators: Seekins, Ben Stevens, Theriault, Wilken, Ellis, Dyson, Guess, Elton & Lincoln
Representatives: Guttenberg, Coplill, Berkowitz
Alaska Moose Federation

DIANNE M. KELLER
MAYOR

CITY OF WASILLA
290 E. Herning Ave.
Wasilla, AK 99654-7091
Phone: (907) 373-9055
Fax: (907) 373-9096

February 25, 2004

Senator Con Bunde
Alaska State Senate
State Capitol Bldg., Rm. 506
Juneau, AK 99801

Dear Senator Bunde:

This letter is written in support of Senate Bill 329 relating to the relocation of "nuisance" moose in urban Alaska to alternative suitable habitat where in rural Alaska where the moose and people will benefit.

The ever-growing moose population continues to pose a significant risk to the health, safety and/or economic well being of people in the area. The populations in cities throughout the state are growing, thus forcing more moose onto our roads, trails, school grounds, and neighborhoods at an alarming rate. Human beings have been placed in danger by the increase in the moose population, and the moose are suffering as well. DOT studies show an increasing amount of moose/vehicle collisions throughout Alaska.

People from all over the state will benefit from this one bill. Public safety is paramount in the cities where the moose populations are at a dangerous surplus and the Alaskan lifestyle is paramount throughout rural Alaska where moose are very scarce. The ability to transplant moose to rural Alaska to help rebuild existing populations seems to make good sense. If organizations like the Alaska Moose Federation are allowed to move moose out of harms way, both the moose and people will benefit.

I look forward to seeing this legislation pass. Thank you for your support of SB 329.

Sincerely,

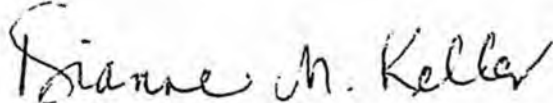

Mayor Dianne M. Keller
City of Wasilla

cc: Alaska Moose Federation



**Anchorage
School
District**

4600 DeBarr Road
P. O. Box 196614
Anchorage, Alaska 99519-6614
(907) 742-4000

SCHOOL BOARD

Jake Metcalfe
President

Tim Steele
Vice President

Mary Marks
Clerk

Macon Roberts
Treasurer

Jeff Friedman

Crystal Kennedy

John Steiner

SUPERINTENDENT

Carol Comeau

March 4, 2004

Alaska Moose Federation
PO Box 231028
Anchorage, AK 99523

Attn. Gary Olson
RE: SB 329

Dear Mr. Olson:

This letter is to confirm my support for your initiative for relocating moose away from our school grounds and in our neighborhoods near schools in the Anchorage School District. We are having increasing numbers of problems for our students who walk to and from school in various neighborhoods, and our principals and teachers report that moose are getting to be more aggressive and a nuisance for our students and staff.

We have had excellent support from Rick Sinnott, and others in protecting our students when we call his department, but this proposed nuisance moose relocation program would insure our students and staff are safe.

Sincerely yours,

Carol Comeau
Superintendent

cc School Board Members
Senator Con Bunde
Larry Wiget, Executive Director, Public Affairs



Municipality of Anchorage

P.O. Box 196650 • Anchorage, Alaska 99519-6650 • Telephone: (907) 343-4431 • Fax: (907) 343-4499 <http://www.muni.org>

Mayor Mark Begich

Office of the Mayor

March 9, 2004

Gary Olson, Chairman
Alaska Moose Federation
P.O. Box 231028
Anchorage, AK 99523

Dear Mr. Olson,

This letter is to show my support for the intention of Senate Bill 329 and the relocation of "nuisance" moose from in and around the Municipality of Anchorage to a more rural setting.

I appreciate the effort of your organization to try to address the growing problem of moose encounters with cars and people that often result in injury for the human, the animals, and also economic costs resulting from damage to property and medical bills.

Public safety is a primary goal of my administration, and efforts to reduce the potential negative consequences of interactions with these magnificent animals should be carefully considered.

My understanding is relocation of the moose will be done with great concern for the health of the animal, and that any costs associated with the program will be assumed by your group or similar private organizations. My support is based on both of those considerations.

Thank you for stepping forward to take on an issue of concern to myself and many Alaskans.

Sincerely,

Mark Begich
Mayor

Communitu. Securitu. Prosperitu.



Municipality of Anchorage

4501 Bragaw Street • Anchorage, Alaska 99507-1599 • Telephone (907) 786-8500 • <http://www.muni.org>



Mayor Mark Begich

Anchorage Police Department

February 26, 2004

To Whom It May Concern:

The Anchorage Police Department offers its general support to the ideas presented by the Alaska Moose Federation through Senate Bill 329.

The Anchorage Police Department recognizes the efforts of the Alaska Moose Federation to maintain the quality and quantity of Alaska's moose populations. Clearly, any efforts to mitigate the potential negative consequences of moose-person interactions also support our primary goals as well. The Anchorage Police Department is currently required to respond to hundreds of moose related incidents a year.

Without having an opportunity to fully evaluate the costs and externalities associated with active intervention plans such as transplanting moose away from the Anchorage Bowl area, we are unable to offer complete unqualified endorsement of SB329. However, we do endorse a sincere investigation into this proposal.

Additionally, the Anchorage Police Department supports the passive measures outlined by the Alaska Moose Federation, which included:

- feasibility study of "wildlife-overpasses"
- directional fencing
- wildlife trail development
- other diversionary methods

Please feel free to contact my assistant, Officer Derek Hsieh at 907-786-2477 with your questions.

Walt Monegan
Chief of Police

Community, Security, Prosperity



March 2, 2004

Gary Olson
Chairman
Alaska Moose Federation
PO Box 231028
Anchorage, AK 99523

Re: Senate Bill #329

Dear Mr. Olson:

The Alaska Zoo has worked with the Alaska Department of Fish and Game (ADFG) for over 35 years – caring for orphaned moose calves, among other things. We have developed the expertise needed to care for young calves - preparing them for transport to the Moose Research Center on the Kenai Peninsula, or to zoos Outside.

The zoo recently upgraded its' moose pens to provide additional flexibility and capacity – allowing us to keep more moose in more areas. One reason we built the pens as we did was the hope that the zoo will participate in research projects valuable to the community of scientists studying moose.

We are ready to partner with ADFG, and groups authorized by the department – like the Alaska Moose Federation – to participate in the management of our moose population. The zoo can provide facilities and personnel to assist in that management.

Gary – you, or other interested parties, are welcome to call me at 346 – 2133 for more information concerning our willingness and ability to work with moose management. I look forward to working with you in the future.

Sincerely,

Louis (Tex) Edwards
Director, Alaska Zoo

ALASKA FEDERATION OF NATIVES, INC.

1577 C Street, Suite 300, Anchorage, Alaska 99501
907-274-3611 Fax 907-276-7989

March 15, 2004

The Honorable Scott Ogan, Chair
State Senate Resources Committee
State Capitol, Room 103
Juneau, AK 99801-1182
VIA FACSIMILE: 907-465-3265

RE: S. 329

Dear Chairman Ogan:

We understand that the State Senate Resources Committee is considering on acting on S. 329, an Act relating to control of nuisance moose, in the near future. If and when the committee considers S. 329, please consider voting in favor of this bill if and only if the State of Alaska will not use its limited financial resources to implement the intent of this bill. Considering the fiscal status of the State of Alaska, we believe that Alaska's limited fiscal resources can be best used for education, health and welfare purposes before they are used to relocate moose.

You may want to consider authorizing the people living in an area where the nuisance moose are located with the right to legally harvest such animals for consumption. This may be the most fiscal means of dealing with nuisance moose, whatever they may be.

Attached, herewith, please find a copy of a resolution that the delegate to the 2003 AFN Convention considered and passed, supporting the efforts of Alaska Moose Federation in enhancing the moose population.

Thank you for your consideration.

Sincerely,

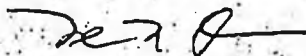

Nelson N. Angapak, Sr.
Vice President

CC: The Honorable Georgianna Lincoln

Attachment: AFN Convention Resolution 03-78

ALASKA FEDERATION OF NATIVES, INC.

2003 ANNUAL CONVENTION

RESOLUTION 03-78

TITLE: IN SUPPORT OF PURPOSE AND EFFORTS OF THE ALASKA MOOSE FEDERATION

WHEREAS: Alaska has many organizations dedicated to maintaining the welfare of certain animal species such as ducks, grouse, wild sheep, elk, bears and fish but until recently, none for the benefit of moose; and

WHEREAS: Urban dwellers seem to think that moose populations across the State are all doing well simply because they see so many in the streets of Anchorage, when in actuality many moose populations in rural Alaska have been experiencing significant declines over the last decade; and

WHEREAS: Other nations in the world that are much smaller than Alaska, with more limited space and habitat successfully produce more moose for human harvest than Alaska currently has for its total number of moose; and

WHEREAS: Moose are extremely important as a basic food source in supporting the seasonal round of harvest that constitutes the subsistence way of life; and

NOW THEREFORE BE IT RESOLVED that the Alaska Federation of Natives supports and endorses the purpose of the Alaska Moose Federation in their efforts to rebuild and enhance moose populations across the State; and

BE IT FURTHER RESOLVED that this resolution should be forwarded to the State of Alaska, RAC and the Federal Subsistence Board.

SUBMITTED BY: ASSOCIATION OF VILLAGE COUNCIL PRESIDENTS

CONVENTION ACTION: SUSPENSION OF RULES/PASSED





1577 "C" Street, Suite 304, Anchorage, Alaska 99501 • (907) 274-5400 • FAX (907) 263-9971 • Email: avi@ruralak.org

March 2, 2004

Gary Olson, Executive Director
Alaska Moose Federation
PO Box 231028
Anchorage, AK 99523

Re: Senate Bill 329

Dear Mr. Olson:

On behalf of Alaska Village Initiatives, I would like to express our support for Senate Bill 329. Senate Bill 329 is a straightforward approach which, if successful, would greatly benefit public safety in urban areas such as Anchorage and Fairbanks. We understand that the Anchorage School District has identified moose as a safety concern for young children attending school, and we support efforts that would increase their safety and well-being.

We are also interested in where the moose will be transported. Many rural areas of the state have moose populations which are insufficient to support pressures from hunting and predation, and supplementing their population would have positive effects.

While the idea of transporting moose is very complex, we are hopeful that scientific and technical expertise would be sufficient to accomplish the task with the highest rate of success and with the most efficient means available.

Please contact us if you have any questions, or if there are ways we can be of assistance.

Sincerely,

Tom Harris
President/CEO



Ninilchik Traditional Council

P.O. Box 39070

Ninilchik, Alaska 99639

Ph: 907 567-3313 / Fx: 907 567-3308

E-mail: ntc@ninilchiktribe-nsn.gov

Web Site: www.ninilchiktribe-nsn.gov

March 8, 2004

Alaska Moose Federation
PO Box 231028
Anchorage, Alaska 99523

Dear Mr. Olsen:

On behalf of the Ninilchik Traditional Council, the Federally and State of Alaska recognized governing body of the Ninilchik Village Tribe, I am sending you this letter to show the support for Senate Bill No. 329 addressing the control and transplanted of nuisance moose. We feel that as good custodians, and in the interest of public safety, we should proactively address these issues.

Thank you.

Sincerely,

A handwritten signature in black ink, appearing to be "Ivan Encelewski". To the right of the signature, the word "for:" is written in a similar cursive style.

Ivan Encelewski
NTC Executive Director

c: file



THOMAS R. PLOOY, CLU, Agent
Auto - Life - Health - Home and Business

2900 Boniface Parkway, Suite 100 Anchorage, Alaska 99504
Bus: 907-333-6575 Fax: 907-333-1186 Res: 907-248-9186

March 10, 2004

Gary Olson
Alaska Moose Federation
PO Box 231028
Anchorage, AK 99523

Dear Gary,

I have been a State Farm agent for over 31 years, and have seen the property damage and body injury a moose can do when they collide with my client's vehicle.

Your proposal to relocate moose is a win-win situation for everyone. The policyholder wins, the insurance company wins, the police department wins, and most importantly, the moose wins, by being relocated to a rural area.

I strongly support SB 329 and look forward to seeing this legislation passed.

Sincerely,

Tom Plooy

A handwritten signature in cursive script that reads "Tom Plooy".

Main Identity

From: "Maggie Strobbe" <maggiedcs@alaska.com>
To: <molson@gci.net>
Sent: Wednesday, March 10, 2004 8:17 PM
Subject: mooseattack

March 10, 2004

Dear Gary,

How odd that you should call us tonight, for just this afternoon I took our daughter, Hannah, to see a counselor regarding the moose attack last summer. She had been asking to see someone that could help her with her fear and anxiety of the woods now, something that I feel will definitely impact our summers up here for years to come. I sat and listened to her story yet once again and am, as always, I amazed that she is still with us.

On June 9, 2003 (about) I was flying back from Atlanta, GA and my husband was at work. My daughter's grandmother was babysitting and Hannah, age 10, and her friend were walking down a well used trail in the lot next to our house, about 20 yards from the edge of our yard, something that they had done numerous times. My husband is an avid outdoorsman and we had cautioned her many times that the woods weren't safe in the spring, but being kids, they were oblivious. Hannah was leading and they apparently walked past a cow with a calf that was bedded down and hidden in the long grass. The moose never saw them until the last moment and they never saw her until it was too late. The cow rushed my daughter and knocked her down, trampling her as she went over, then she turned around and trampled her again. Hannah then saved her own life by curling into a ball and staying there. She listened until she heard the cow call her calf and left. Then got up and walked out of the woods with a broken collar-bone, a compression fracture to the back of her skull and an ear that was practically torn from her head. By that time a neighbor had called 911 and her grandmother was struggling to get to her. Within minutes the fire department, police and paramedics were at our house and treating her (no doubt that OUR house is in the 911 database). She was rushed to Providence Hospital where the doctors sewed her ear back on and she was x-rayed and sent home in a sling for her collarbone. Several days later, we took her back for a CAT scan of her skull because she was having dizzy spells and headaches. Luckily, there was no bleeding under her skull where she was kicked, but we were eventually forced to have surgery to plate her collarbone. The force of the moose's first attack had not only broken the bone, but also pushed one end of it behind the muscle so that surgical intervention was necessary. I feel absolutely that our daughter could have died, if just one of those kicks was less glancing and more direct.

This is an accident without guilty parties. The moose was simply protecting her calf and my daughter and her friend were simply walking down a trail. I have lived here 24 years and feel that the moose have transformed from an occasional amusing spectacle to a dangerous population. If I had so wanted a more rustic lifestyle we would certainly not live in Alaska's largest city. We can't hunt them in the Anchorage area, so what are our options to protect our children and ourselves?

Thank you for trying to find a win-win solution to this escalating problem.

Sincerely,

Maggie & Steve Strobbe
maggiedcs@aol.com
907-346-40094

3/10/2004

PERMISSION TO USE PHOTOGRAPH & QUOTE

I authorize The Alaska Moose Federation and/or Gary Olson to use photographs of my daughter, Hannah Strobbe, a minor, and the quote from me for educational or promotional purposes in conjunction with senate bill #329. The photographs or the quote may not be used for profit without my express permission. I understand that I will not be paid or rewarded for providing this authorization.

Signature:

Margaret D.C. Strobbe

Printed Name:

MARGARET D.C. Strobbe

Date:

3/12/04



Picture of Hannah 2 days after moose attack.

Oliver E. Burris
2801 Talkeetna Avenue
Fairbanks, AK 99709
907 474-0437

The Honorable Senator Con Bundy
State Capitol
Juneau, AK 99801-1182

Dear Senator Bundy:

Thank you for sponsoring SB329 to allow the transplanting of moose from the Anchorage Bowl Area.

I organized the capture and transplant of bison from Delta Junction to May Creek and Farewell. Also the capture and transplant of caribou from Chistochina to the Kenai Peninsula. These transplants were done with adult and subadult animals. The transplant of moose from the Anchorage Bowl will help to alleviate many public safety problems. You may already be aware of the cost to Alaskans in human casualties and property damage. The Alaska Moose Federation has documented these tremendous costs to the public and our economy.

Transplanting adult, subadult and calf moose is a practical way to help reduce moose problems. The Board of Game unanimously supported the bill on March 10, 2004. The Division cautioned the Board because of concerns that the private transplant efforts may put additional strain on the already reduced budget of the Division of Wildlife Conservation. Ron Somerville suggested that we could learn more about the effects of transplanting moose by radio collaring them. The Department reiterated that the Board's preceding actions to more actively manage moose in several intensive management areas would already be a burden on Division budgets.

Clearly the benefit of your bill will be to reduce the severe problems in the Anchorage Bowl. The benefits to areas where moose may be transplanted is a secondary benefit. It will not put additional strain on Fish and Game budgets unless they choose to become financially involved.

I am on the Advisory Board of the Alaska Moose Federation. I have been involved with the planning and design since its' inception. I would enjoy discussing moose management in the Anchorage area and other areas in our State. I have stayed actively involved in wildlife management since I retired from the Game Division in 1986 after 25 years with the Division.

Sincerely yours,

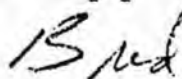

Oliver "Bud" Burris

Email:

Non Constituent Supports

BILL#: SB 329 NUISANCE MOOSE

SUBJECT:

MESSAGE: Please pass this bill. As the Chairman of the Central Kuskokwim Fish and Game Advisory Committee we support this bill.

DISTRIBUTION: 12

Lawrence F Ctibor

Po Box 1201

Po Box 1201

Bethel AK, 99559

Lower Kuskokwim SD

Email: larry_ctibor@lksd.org

Subject: SB 329

Date: Mon, 15 Mar 2004 18:20:56 -0900

From: "Vern Aiton" <vern@wildak.net>

To: "Senator Bunde" <Senator.Con.Bunde@legis.state.ak.us>

From;
Vern Aiton
Acting Secretary
Delta Fish & Game Advisory Committee

Senator,

I apologize for the confusion caused by the inadvertent fax regarding our opposition to your SB 329. Unknowingly, you were sent one members position paper and not the Advisory Committee's vote results.

The Delta AC voted 5 to 3 for support of SB 329.

Sorry for the confusion.

Vern Aiton
Delta AC

Subject: [Fwd: SB 329]

Date: Tue, 16 Mar 2004 15:22:54 -0900

From: Con Bunde <Senator_Con_Bunde@Legis.state.ak.us>

Organization: Alaska State Legislature

To: Senator Johnny Ellis <Senator_Johnny_Ellis@legis.state.ak.us>,
Senator Georgianna Lincoln <Senator_Georgianna_Lincoln@legis.state.ak.us>,
Senator Ralph Seekins <Senator_Ralph_Seekins@legis.state.ak.us>,
Representative John Harris <Representative_John_Harris@legis.state.ak.us>,
Representative Cheryll Heinze <Representative_Cheryll_Heinze@legis.state.ak.us>,
Senator Scott Ogan <Senator_Scott_Ogan@legis.state.ak.us>,
Linda Hay <Linda_Hay@legis.state.ak.us>

Colleagues,

We all received a fax from Darrel Darland of the Delta Junction Fish and Game Advisory Committee on March 11, 2004 indicating the committee's position on several bills. One of the bills listed was SB 329, "An Act relating to the control of nuisance moose." The fax indicated reasons they opposed SB 329 but also indicated a vote to support it was 8-0-0.

I spoke to Mr. Vern Aiton, the Acting Secretary of the committee, and asked him to clarify the committee's position. He sent the following message to me.

If you have any questions, please feel free to contact me at any time.

Con

----- Original Message -----

Subject: SB 329

Date: Mon, 15 Mar 2004 18:20:56 -0900

From: "Vern Aiton" <vern@wildak.net>

To: "Senator Bunde" <Senator.Con.Bunde@legis.state.ak.us>

From: Vern Aiton Acting Secretary Delta Fish & Game Advisory Committee Senator, I apologize for the confusion caused by the inadvertent fax regarding our opposition to your SB 329. Unknowingly, you were sent one members position paper and not the Advisory Committee's vote results. The Delta AC voted 5 to 3 for support of SB 329. Sorry for the confusion. Vern Aiton Delta AC



**SATELLITE
TV**

**Local Channels
Now Available!**



Anchorage Daily News

Print Page

Close Window

Moose carnage prompts concern

PROPOSAL: Group aims to curb collisions, conserve ungulates.

By DOUG O'HARRA
Anchorage Daily News

(Published: February 22, 2004)

Alaskans have been crashing cars and trucks into moose about five or six times per day since the start of the year.

The carnage includes a tragedy near Mile 105 of the Parks Highway on Jan. 5. John J. High of Trapper Creek died after his Subaru Legacy smashed into a moose with hardly enough time to tap the brakes. A family man survived by his wife and two young children, High was driving home from work.

That same day, drivers near Willow, Sutton, Palmer, Wasilla, Kenai and Seward also plowed into moose, according to the Alaska State Troopers. These were among more than 230 moose knocked down on rural highways since Jan. 1, about 100 more than the same period last year.

At least 16 people have been hospitalized or hurt, while hundreds have limped their cars home with dented fenders and shattered glass.

In Anchorage, where deep snow has driven an estimated 1,000 moose into neighborhoods, parks and streets, more than 120 moose have been killed since summer.

The specter of a huge brown animal lurking at the fringe of headlights continues to be the white-knuckle nightmare of every Alaska driver: 1,000 pounds of meat and bone threatening to bolt across your path.

Driving highways becomes a seasonal moose roulette that annually kills one to three people and injures at least 100 more. Last March, a 13-year-old boy died when a car driven by his mother crashed into a moose dashing across the Glenn Highway near the weigh station.

Even when no one gets hurt, moose collisions cost millions of dollars in property damage and lost time, and leaves hundreds of wild animals mangled by the roadside.

Despite fences, lights and periodic campaigns to alert drivers or get them to slow down, the annual toll has averaged 650 across the state and 155 inside Anchorage since the early 1990s.

Biologists and wildlife advocates say the current situation unnecessarily risks lives while wasting one of the state's most valued food resources and wildlife icons.

Most of the moose kills in the Anchorage Bowl are from cars -- not predators, said Anchorage area biologist Rick Sinnott, with the Alaska Department of Fish and Game. "We salvage as many of the moose as possible for human food, but I'd guess dozens die that aren't found until it's too late to salvage them."

Each accident can easily cost thousands of dollars, often more than the vehicle is worth, said Nancy Carpenter, spokeswoman for State Farm Insurance in Alaska.

"Our claims adjusters look at anywhere from three to six moose-car type collisions per week in the winter," she said. "Because of the stature of the animal, their height and their long legs, they tend to get tossed onto the car, doing significant damage to hoods and windshields."

But a new statewide group wants to sponsor an aggressive program to conserve moose and head off accidents. The Alaska Moose Federation wants to find a way to transplant up to 250 moose per year out of Anchorage into rural areas with open habitat.

A "nuisance moose" bill introduced this month by Sen. Con Bunde, R-Anchorage, would authorize that.

The group proposes to raise money for research or to help build structures to keep moose off roads. With a board of advisers that includes the governor and the state's congressional delegation, the federation hopes to launch a moose movement that will include youth moose troops. Its Web site is www.growmoremoose.org.

"What we're in right now is absolute genocide, with everyone in Mat-Su and Anchorage and the Kenai playing Russian roulette at night with their vehicles," said Gary Olson, the group's organizer and chairman. "Regardless of your perspective, it's unacceptable."

At the same time, state and federal biologists have been pushing detailed studies of new road projects to find ways to reduce moose-car crashes.

Planners working on an extension of Bragaw Road across the Campbell Creek bottomland in Anchorage are also trying to find some recipe of fences, lighting and underpasses to keep moose off the road.

"It's a big issue on this project," said Kristen Hansen, with Dowl Engineers.

The Alaska experience with moose mirrors a growing crisis in some Lower 48 cities with exploding deer populations. In a sense, the phenomenon is part of a broad ecological shift that allows human-tolerant animals to thrive near settlements without fear of natural predators. With habitat crisscrossed by roads, these animals must negotiate traffic to feed or bed down.

All these factors converge in Anchorage. Park-side boulevards like Tudor Road and Lake Otis Parkway, and Hillside collectors like Abbott and O'Malley and Rabbit Creek roads, concentrate the problem.

"It's a bad death zone in town because the moose are moving down through from the hills and coming out of (Far North) Bicentennial Park," said assistant state biologist Jessy Coltrane. "In order for moose to reach habitat, they have to cross a lot of high-speed, high-volume roads, and there's really no crossing structures."

Through the end of January, Anchorage drivers had killed 28 more moose than they had by the same time last winter. Since October, Sinnott and Coltrane have shot 20 crippled moose and found a couple of dozen others dead from unknown causes.

"It could be that they're dying of internal injuries, that they got hit by a car," Coltrane said. "Or it could be that they're feeding on garbage and they're getting blocked up."

Motorists north and south of Anchorage are also smashing into moose more often than usual, though the Alaska Railroad has reduced crashes from the 1990s. Through last week, the death toll was 286 moose on Mat-Su roads, and 276 moose on the Kenai, according to state biologists. Trains have killed 57 moose through Friday, including eight inside Anchorage and 27 in Mat-Su, said chief engineer Tom Brooks.

"We're probably on track to have either the second or third highest road kill numbers since we started keeping records," said Mat-Su-area state biologist Gino Del Frate.

Finding a long-term solution to the problem means finding where moose migrate during winter and why, preferably by tracking moose with collars, said Kenai-area biologist Jeff Selinger. That would allow planners to design specific fixes for specific stretches of roads, whether fencing, lights, by-passes or changing vegetation.

High moose numbers in Anchorage and reports of low moose numbers in some rural areas inspired Olson to propose moving the city moose out of town. He argues that Anchorage could serve as a kind of moose incubator.

"We need to take moose where they are a liability right now and move them into an area where they are an asset, and that's something that's never been done before," he said. "This could go a long way to heal the rural-urban divide in this state."

But Sinnott, responsible for managing the city's moose, said transplanting moose presents logistical problems. Catching so many moose would be a full-time job that would become increasingly difficult after "the dumb ones" got snatched. Only certified people working under the supervision of a veterinarian can use the drugs that knock out and revive moose.

And then there would be other matters to resolve: Should moose be immobilized for hours, or allowed to wake up inside a trailer? Could an adult moose ride in an airplane safely? Would city-born moose survive when faced for the first time with wolves or an unfamiliar forest.

Still, it's worth thinking about, Sinnott said. "And it may be worth doing some limited experimentation."

The federation organizers are "very sincere and their heart is in the right place," he added. "They just need to do the right thing, and I think they're willing to do that. But I don't think we know what the right thing is right now."

Meanwhile the carnage marches on. On Feb. 12, an ordinary winter Thursday, drivers in Livengood, Nenana, Richardson, Tazlina, Palmer and Wasilla killed moose, according to the Alaska State Troopers. On Abbott Road of the Anchorage Hillside, a yearling bull leapt in front of a Dodge pickup heading east from Lake Otis Parkway at 6:17 a.m.

The result was typical: the truck sustained damage to the right front fender; the moose broke its legs, couldn't get up and was shot by police. The driver, Anchorage resident Travis Parry, was unhurt and received no citation, police said.

"The problem is that moose are so dark, and that area there is not well lit," said patrol officer Michael Busey. "If the moose walked out in front of him, there's not much he could do."

The moose was so mangled that only 40 pounds of meat could be salvaged for hamburger for two needy families, said Troy Nicholson, an Army National Guard sergeant who collected the carcass an hour later.

"I'm sure the vehicle just saw it at the last minute," said Nicholson, who himself ran into moose with his truck three years ago in Turnagain Pass, sustaining \$13,000 in damage.

Daily News reporter Doug O'Harra can be reached at do'harra@adn.com.

Print Page

Close Window

Copyright © 2004 The Anchorage Daily News (www.adn.com)

THE
FOLLOWING
DOCUMENT(S)
ARE
POOR
ORIGINAL
COPIES

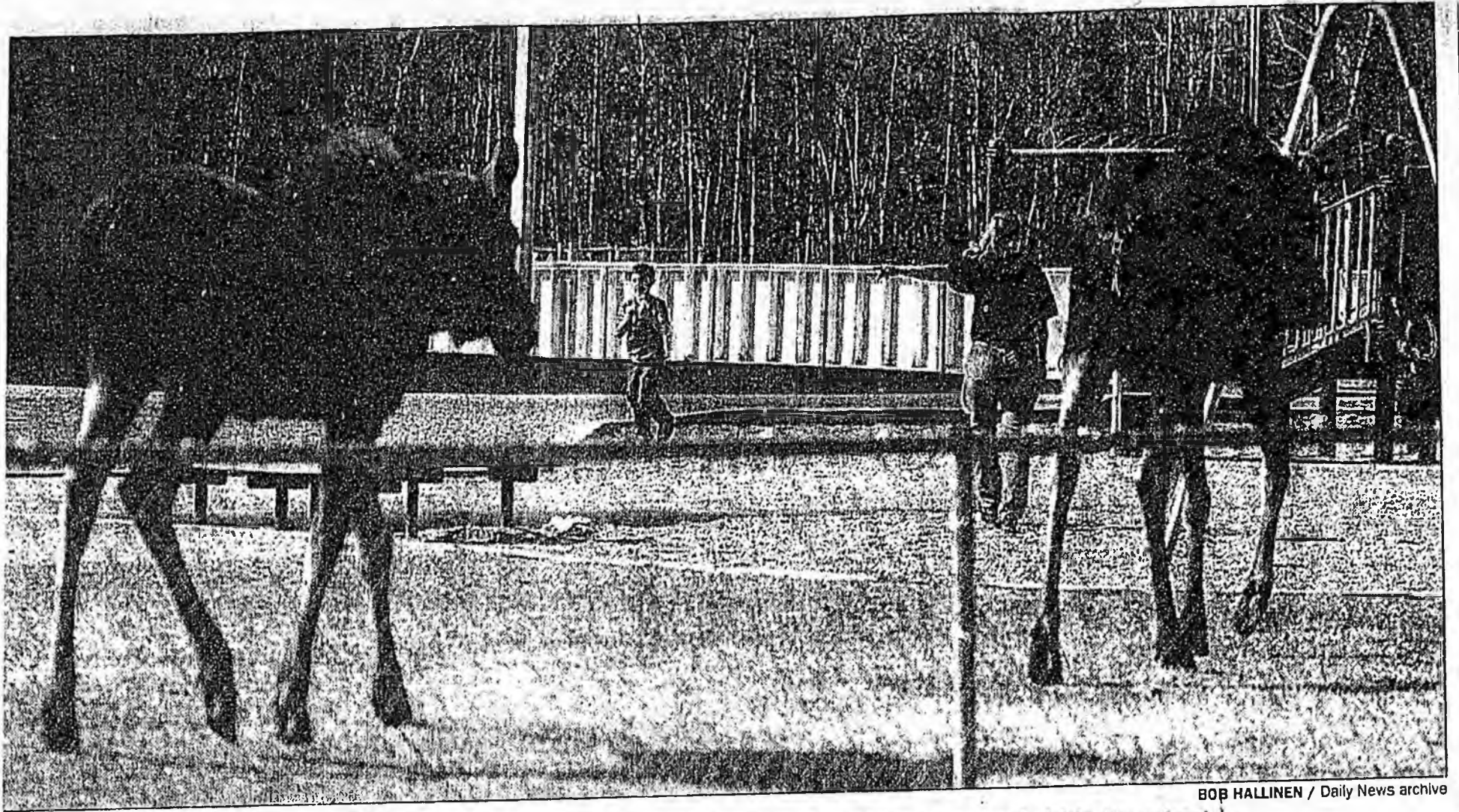

BOB HALLINEN / Daily News archive

A moose and her calf walk through the Turnagain Elementary School playground as children are herded into the school.

Anchorage Daily News

Friday, February 10, 2004

ALASKA'S NEWSPAPER

www.adn.com

FAIRBANKS MOOSE COMES TO THE END OF THE LINE



ERIC ENGMAN / Fairbanks Daily News-Miner

A bull moose lunged as Golden Valley Electric Association linemen Walt Becker, right, tried to free it from an old electric line Saturday afternoon in Fairbanks. Alaska Bureau of Wildlife Enforcement officers and GVEA workers tracked the moose as it ran through residential yards and into a wooded area, dragging the line behind it. The moose was shot and killed after it turned and charged a wildlife officer.

adn.com
Anchorage Daily News

ANCHORAGE
CONCERT ASSOCIATION
www.anchorageconcerts.org

Battlefield Band
 Scotland's Best Live Act!
 2003 Scotland Traditional Music Awards
THURSDAY, APRIL 8 - 7:30PM ATWOOD CONCERT HALL



- Registration
- Alaska
- Money
- Sports
- Outdoors
- Life
- Entertainment
- Obituaries
- Perfect World
- Video Clips
- Legislature
- Opinion
- Letters to the Editor
- Voice of the Times
- Corrections
- Weather
- ADN Links
- Newsletters
- ADN Store
- Help
- Home

PHOTO GALLERY

4 Photo index | ADN ho



Road Hog!: A moose was herded down East Northern Lights on Sunday morning as it looked to browse for food. *(Jim Lavrakas)*

Image No. 2 of 410 | Published: March 12, 2004

◀ Previous photo

E-mail this photo

Next photo ▶

Search

In today's news

Search

- Previous days' news
- Advanced search
- Archives search

Editors' Picks

Read adn.com's best recent stories.

Top Ten Stories

See which stories other readers are sending to their friends.



Alaska State Legislature

Please enter into the record my testimony to the SRES
committee name
committee on SB 329, dated 3/24/04
bill/subject

I'd like to say it's about time somebody down in Juneau has finally realized that moose can be a nuisance. The last time I looked at the Brake for Moose sign on the Highway we had already hit over 350 moose this season. This is a ridiculous way of harvesting big Game. It ruins the meat, destroys our vehicles and scares the Hell out of us.

It is my opinion that Nuisance Moose should be shot on sight. Alaska State Troopers and the Dept. of Fish and Game Officers should be responsible for shooting the moose. It would take less time than responding to an accident and therefore save money as well as saving the meat. If you want to send moose to ~~the~~ rural areas they should be frozen first. That way people will eat the moose instead of wolves or bears. If you don't want to send the moose to the bush you can dispose of it the same way we do with road killed moose or you can donate it to Bean's Cafe or the Alaska Zoo.

The bottom line is that the moose are dead whether they are shot or hit by a car. Transporting ~~live~~ live moose will be a boondoggle where as clearing our roads of nuisance moose is long overdue.

I've had moose run out in front of me and if we had time I'd share my "Close Encounters of the Third Kind."
The Paint Ball Technique could be made to work.
It doesn't make any sense to me to knock down a moose in Wasilla and then fly it live to the bush with the intent that it should be killed by a rural hunter.

Email:

Non Constituent Supports

BILL#: SB 329 NUISANCE MOOSE

SUBJECT:

MESSAGE: Please pass this bill. As the Chairman of the Central Kuskokwim Fish and Game Advisory Committee we support this bill.

DISTRIBUTION: 12

Lawrence F Ctibor

Po Box 1201

Po Box 1201

Bethel AK, 99559

Lower Kuskokwim SD

Email: larry_ctibor@lksd.org

Subject: SB 329

Date: Mon, 15 Mar 2004 18:20:56 -0900

From: "Vern Aiton" <vern@wildak.net>

To: "Senator Bunde" <Senator.Con.Bunde@legis.state.ak.us>

From;
Vern Aiton
Acting Secretary
Delta Fish & Game Advisory Committee

Senator,

I apologize for the confusion caused by the inadvertent fax regarding our opposition to your SB 329. Unknowingly, you were sent one members position paper and not the Advisory Committee's vote results.

The Delta AC voted 5 to 3 for support of SB 329.

Sorry for the confusion.

Vern Aiton
Delta AC

Subject: [Fwd: SB 329]

Date: Tue, 16 Mar 2004 15:22:54 -0900

From: Con Bunde <Senator_Con_Bunde@Legis.state.ak.us>

Organization: Alaska State Legislature

To: Senator Johnny Ellis <Senator_Johnny_Ellis@legis.state.ak.us>,
Senator Georgianna Lincoln <Senator_Georgianna_Lincoln@legis.state.ak.us>,
Senator Ralph Seekins <Senator_Ralph_Seekins@legis.state.ak.us>,
Representative John Harris <Representative_John_Harris@legis.state.ak.us>,
Representative Cheryll Heinze <Representative_Cheryll_Heinze@legis.state.ak.us>,
Senator Scott Ogan <Senator_Scott_Ogan@legis.state.ak.us>,
Linda Hay <Linda_Hay@legis.state.ak.us>

Colleagues,

We all received a fax from Darrel Darland of the Delta Junction Fish and Game Advisory Committee on March 11, 2004 indicating the committee's position on several bills. One of the bills listed was SB 329, "An Act relating to the control of nuisance moose." The fax indicated reasons they opposed SB 329 but also indicated a vote to support it was 8-0-0.

I spoke to Mr. Vern Aiton, the Acting Secretary of the committee, and asked him to clarify the committee's position. He sent the following message to me.

If you have any questions, please feel free to contact me at any time.

Con

----- Original Message -----

Subject: SB 329

Date: Mon, 15 Mar 2004 18:20:56 -0900

From: "Vern Aiton" <vern@wildak.net>

To: "Senator Bunde" <Senator.Con.Bunde@legis.state.ak.us>

From: Vern Aiton
Acting Secretary
Delta Fish & Game Advisory Committee
Senator, I apologize for the confusion caused by the inadvertent fax regarding our opposition to your SB 329. Unknowingly, you were sent one members position paper and not the Advisory Committee's vote results. The Delta AC voted 5 to 3 for support of SB 329. Sorry for the confusion. Vern Aiton
Delta AC

PERMISSION TO USE PHOTOGRAPH & QUOTE

I authorize The Alaska Moose Federation and/or Gary Olson to use photographs of my daughter, Hannah Strobbe, a minor, and the quote from me for educational or promotional purposes in conjunction with senate bill #329. The photographs or the quote may not be used for profit without my express permission. I understand that I will not be paid or rewarded for providing this authorization.

Signature:

Margaret D.C. Strobbe

Printed Name:

MARGARET D.C. STROBBE

Date:

3/12/04



**Local Channels
Now Available!**



Anchorage Daily News

Print Page

Close Window

Moose carnage prompts concern

PROPOSAL: Group aims to curb collisions, conserve ungulates.

By DOUG O'HARRA
Anchorage Daily News

(Published: February 22, 2004)

Alaskans have been crashing cars and trucks into moose about five or six times per day since the start of the year.

The carnage includes a tragedy near Mile 105 of the Parks Highway on Jan. 5. John J. High of Trapper Creek died after his Subaru Legacy smashed into a moose with hardly enough time to tap the brakes. A family man survived by his wife and two young children, High was driving home from work.

That same day, drivers near Willow, Sutton, Palmer, Wasilla, Kenai and Seward also plowed into moose, according to the Alaska State Troopers. These were among more than 230 moose knocked down on rural highways since Jan. 1, about 100 more than the same period last year.

At least 16 people have been hospitalized or hurt, while hundreds have limped their cars home with dented fenders and shattered glass.

In Anchorage, where deep snow has driven an estimated 1,000 moose into neighborhoods, parks and streets, more than 120 moose have been killed since summer.

The specter of a huge brown animal lurking at the fringe of headlights continues to be the white-knuckle nightmare of every Alaska driver: 1,000 pounds of meat and bone threatening to bolt across your path.

Driving highways becomes a seasonal moose roulette that annually kills one to three people and injures at least 100 more. Last March, a 13-year-old boy died when a car driven by his mother crashed into a moose dashing across the Glenn Highway near the weigh station.

Even when no one gets hurt, moose collisions cost millions of dollars in property damage and lost time, and leaves hundreds of wild animals mangled by the roadside.

Despite fences, lights and periodic campaigns to alert drivers or get them to slow down, the annual toll has averaged 650 across the state and 155 inside Anchorage since the early 1990s.

Biologists and wildlife advocates say the current situation unnecessarily risks lives while wasting one of the state's most valued food resources and wildlife icons.

Most of the moose kills in the Anchorage Bowl are from cars -- not predators, said Anchorage area biologist Rick Sinnott, with the Alaska Department of Fish and Game. "We salvage as many of the moose as possible for human food, but I'd guess dozens die that aren't found until it's too late to salvage them."

Each accident can easily cost thousands of dollars, often more than the vehicle is worth, said Nancy Carpenter, spokeswoman for State Farm Insurance in Alaska.

"Our claims adjusters look at anywhere from three to six moose-car type collisions per week in the winter," she said. "Because of the stature of the animal, their height and their long legs, they tend to get tossed onto the car, doing significant damage to hoods and windshields."

But a new statewide group wants to sponsor an aggressive program to conserve moose and head off accidents. The Alaska Moose Federation wants to find a way to transplant up to 250 moose per year out of Anchorage into rural areas with open habitat.

A "nuisance moose" bill introduced this month by Sen. Con Bunde, R-Anchorage, would authorize that.

The group proposes to raise money for research or to help build structures to keep moose off roads. With a board of advisers that includes the governor and the state's congressional delegation, the federation hopes to launch a moose movement that will include youth moose troops. Its Web site is www.growmoremoose.org.

"What we're in right now is absolute genocide, with everyone in Mat-Su and Anchorage and the Kenai playing Russian roulette at night with their vehicles," said Gary Olson, the group's organizer and chairman. "Regardless of your perspective, it's unacceptable."

At the same time, state and federal biologists have been pushing detailed studies of new road projects to find ways to reduce moose-car crashes.

Planners working on an extension of Bragaw Road across the Campbell Creek bottomland in Anchorage are also trying to find some recipe of fences, lighting and underpasses to keep moose off the road.

"It's a big issue on this project," said Kristen Hansen, with Dowl Engineers.

The Alaska experience with moose mirrors a growing crisis in some Lower 48 cities with exploding deer populations. In a sense, the phenomenon is part of a broad ecological shift that allows human-tolerant animals to thrive near settlements without fear of natural predators. With habitat crisscrossed by roads, these animals must negotiate traffic to feed or bed down.

All these factors converge in Anchorage. Park-side boulevards like Tudor Road and Lake Otis Parkway, and Hillside collectors like Abbott and O'Malley and Rabbit Creek roads, concentrate the problem.

"It's a bad death zone in town because the moose are moving down through from the hills and coming out of (Far North) Bicentennial Park," said assistant state biologist Jessy Coltrane. "In order for moose to reach habitat, they have to cross a lot of high-speed, high-volume roads, and there's really no crossing structures."

Through the end of January, Anchorage drivers had killed 28 more moose than they had by the same time last winter. Since October, Sinnott and Coltrane have shot 20 crippled moose and found a couple of dozen others dead from unknown causes.

"It could be that they're dying of internal injuries, that they got hit by a car," Coltrane said. "Or it could be that they're feeding on garbage and they're getting blocked up."

Motorists north and south of Anchorage are also smashing into moose more often than usual, though the Alaska Railroad has reduced crashes from the 1990s. Through last week, the death toll was 286 moose on Mat-Su roads, and 276 moose on the Kenai, according to state biologists. Trains have killed 57 moose through Friday, including eight inside Anchorage and 27 in Mat-Su, said chief engineer Tom Brooks.

"We're probably on track to have either the second or third highest road kill numbers since we started keeping records," said Mat-Su-area state biologist Gino Del Frate.

Finding a long-term solution to the problem means finding where moose migrate during winter and why, preferably by tracking moose with collars, said Kenai-area biologist Jeff Selinger. That would allow planners to design specific fixes for specific stretches of roads, whether fencing, lights, by-passes or changing vegetation.

High moose numbers in Anchorage and reports of low moose numbers in some rural areas inspired Olson to propose moving the city moose out of town. He argues that Anchorage could serve as a kind of moose incubator.

"We need to take moose where they are a liability right now and move them into an area where they are an asset, and that's something that's never been done before," he said. "This could go a long way to heal the rural-urban divide in this state."

But Sinnott, responsible for managing the city's moose, said transplanting moose presents logistical problems. Catching so many moose would be a full-time job that would become increasingly difficult after "the dumb ones" got snatched. Only certified people working under the supervision of a veterinarian can use the drugs that knock out and revive moose.

And then there would be other matters to resolve: Should moose be immobilized for hours, or allowed to wake up inside a trailer? Could an adult moose ride in an airplane safely? Would city-born moose survive when faced for the first time with wolves or an unfamiliar forest.

Still, it's worth thinking about, Sinnott said. "And it may be worth doing some limited experimentation."

The federation organizers are "very sincere and their heart is in the right place," he added. "They just need to do the right thing, and I think they're willing to do that. But I don't think we know what the right thing is right now."

Meanwhile the carnage marches on. On Feb. 12, an ordinary winter Thursday, drivers in Livengood, Nenana, Richardson, Tazlina, Palmer and Wasilla killed moose, according to the Alaska State Troopers. On Abbott Road of the Anchorage Hillside, a yearling bull leapt in front of a Dodge pickup heading east from Lake Otis Parkway at 6:17 a.m.

The result was typical: the truck sustained damage to the right front fender; the moose broke its legs, couldn't get up and was shot by police. The driver, Anchorage resident Travis Parry, was unhurt and received no citation, police said.

"The problem is that moose are so dark, and that area there is not well lit," said patrol officer Michael Busey. "If the moose walked out in front of him, there's not much he could do."

The moose was so mangled that only 40 pounds of meat could be salvaged for hamburger for two needy families, said Troy Nicholson, an Army National Guard sergeant who collected the carcass an hour later.

"I'm sure the vehicle just saw it at the last minute," said Nicholson, who himself ran into moose with his truck three years ago in Turnagain Pass, sustaining \$13,000 in damage.

Daily News reporter Doug O'Harra can be reached at do'harra@adn.com.

Print Page

Close Window

Copyright © 2004 [The Anchorage Daily News \(www.adn.com\)](http://www.adn.com)